



IDW520 ID Photo System User Guide for Version 1.5

Contents

Before You Begin	6	Preparing the Camera	19
Important Safety Instructions	7	Setting up the QW410-iD Printer . . .	20
General Safety Precautions	8	Connecting the Printer	20
Contact Us	9	Installing the Printer Paper	22
Introduction	10	Replacing the Printer Ribbon	25
What is the IDW520?	11	Using the IDW500A Printer	27
New Features in IDW v1.5	12	About your Printer	27
New Features in IDW v1.4	12	Replacing the Printer Paper and Ink Ribbon Print Pack	27
New Features in IDW v1.3	13	Maintaining the Printer	32
IDW520 System Components	14	Cleaning the Platen Roller	32
IDW520 Console	15	Cleaning the Thermal Print Head	33
Your Camera Controls	16	Repacking the Printer	36
Installation	18	Troubleshooting Printer Issues . .	37
		Clearing Paper Jams	37

Repairing Damaged Ribbons . . .	38	Printer Icon	60
Setting Up the IDW520 Console . . .	40	Camera Icon	61
Using the IDW520 System	41	Software Version	61
Turning ON the System	43	ID Photo Template	61
Operating the IDW520 System	44	Using the Thumbnail Image Gallery	62
Take a Passport Photo	44	Using the Operations Bar	64
Transfer the Image	48	Editing Images	65
Auto Image Transfer Mode (new in		Reprinting an Image	68
v1.3)	48	Auto-Transfer Mode	68
DPOF Transfer Mode	49	Reprinting an Image (continued)	69
Print Button Location for IDW Camera		DPOF Transfer Mode	69
50		Importing Images via the USB port	70
Image Transfer Selection Gallery	52	Image Processing	72
Image Thumbnail View Mode	53	Changing the ID Photo Template	73
Print the Image	54	Printing Full Page Photos	75
Saving Images to a USB Drive	58	Deleting an Image from the Camera	76
About the ID Photo Dashboard	59	Deleting all Images on the Camera	77
Understanding the Status Bar	60	Using the Flash	78

Adding a Custom Template	79	Maintenance Screen Information .	99
Printer Queue	82	Admin Mode	100
About your ID Photo Printer	84	Changing the Admin Password	101
Getting to know your Printer	85	Using LaunchPad	102
Setting up the Printer	86	SD Card Utility	103
Replacing the Printer Paper	86	ez Share SD Card Procedures .	104
Replacing the Printer Ribbon	88	Important Information:	
Administrative Actions	90	Using Multiple Systems in Close Prox-	
About Administrative Actions	91	imity	104
Behaviors Section	93	Setting the ez Share SSID Number	
Imaging Section	95	105	
Print Section	96	Repairing the ez Share SD Card	116
ICAO Compliance Certification	96	Toshiba FlashAir Card Procedures	119
ID Types	97	Setting the FlashAir SSID Number	119
System Section	97	Repairing the FlashAir SD Card	121
About the Maintenance Screen	98	Install Local Updates	122
		Quick Support	124
		Clear Images Queue	125
		Resending Images from the Camera	126

Restart Device	127
Shutdown Device	128
Troubleshooting	129
General Troubleshooting Steps . . .	130
Acknowledgements	132
License Agreements	133
Other Agreements	136
Appendix A: Supported Countries	139
Supported Countries	140

Before You Begin

In this Chapter

Important Safety Instructions	7
General Safety Precautions	8
Contact Us	9

Important Safety Instructions

Safety is paramount when installing and operating the system. These safety instructions are to protect you and the customer and the overall public. The following bullet points apply to the safety instructions in this manual:

- ❖ Read all of these instructions before setting up, installing, and operating your system.
- ❖ Follow all warnings, safety precautions, and notices for all procedures in this manual.
- ❖ When in doubt, stop what you are doing and reassess the safety of the situation or procedure. Never continue with a step or procedure when there is the slightest doubt regarding safety.
- ❖ Save these instructions for future reference.

General Safety Precautions

- ❖ Never install or setup the system near water.
- ❖ Never place the system on an unstable platform.
- ❖ Never place the system near a heat source, such as a heater or furnace.
- ❖ Never perform any of these steps while wearing jewelry (rings, loose necklaces, bracelets, etc.), neckties, or other clothing that could get caught in the equipment. These items can get caught in the equipment or may conduct electricity and cause injury.
- ❖ Never insert any foreign object into the system unit without powering the system OFF first.
- ❖ Never block ventilation ports; allow plenty of room around the system for ventilation.
- ❖ Never use water or liquid to extinguish a fire on the system unit.
- ❖ Always protect the power cord from accidental kinks, cuts, and foot traffic.
- ❖ Always operate this system from the correct type of grounded power source.
- ❖ Always clean and maintain the system in the prescribed manner as instructed in this manual.
- ❖ Always use this equipment in the specified manner as recommended by the manufacturer.
- ❖ Failure to observe safety precautions voids your warranty and may cause damage to the unit and could result in personal injury or death.

Contact DNP Imagingcomm America Corporation immediately if:

- ❖ The system is damaged due to fire or flood; or is otherwise unsafe to operate.
- ❖ Any part of the system is dropped, cracked, or is not operating properly after performing cleaning and maintenance.
- ❖ You have any questions not answered in this manual.

Contact Us

Need help? Contact DNP Imagingcomm America Corporation:

DNP Imagingcomm America Corp.

4524 Enterprise Drive NW

Concord, NC 28027

Phone: 704-784-8100

Fax: 704-784-7196

www.dnpimagingcomm.com

www.dnpphoto.com

Technical Support Contact Information

Phone US and Canada: 1-855-367-7604 or +1-980-777-1178

Phone Latin America: 1-855-367-8008 or +1-980-777-1175

Email: dnpsupport@dnp.imgcomm.com

Introduction

In this Chapter

What is the IDW520?	11
New Features in IDW v1.5	12
New Features in IDW v1.4	12
New Features in IDW v1.3	13
IDW520 System Components	14
IDW520 Console	15
Your Camera Controls	16

What is the IDW520?

The IDW520 is a **wireless passport and ID photo printing system** designed to easily create and print passport photos for your customers. In a matter of minutes, you can take a picture, transfer the image to the IDW520 console, approve the image, and have it print completely formatted ID photos in the template of your choosing. A host of country specific templates are available for passport, visa, and state IDs. You can also make minor color and rotation adjustments to images when necessary. Using the IDW520 console, monitor your printer for media usage and possible error conditions. The IDW520 provides fast photo production. It automatically prints images that meet the proper biometric requirements, and allows editing or reprinting of images as needed.

New Features in IDW v1.5

Digital Upload File for US Passport Renewal

When using the **Copy to USB** function with the US Passport template, an additional file will be exported to the USB for the customer's **Digital Upload**. The additional saved image file is processed by the IDW system and sized to be compatible with the **US Passport Online Renewal** process.

The IDW520 can be updated locally using a USB flash drive. Contact DNP Technical Support for info.

NOTE: The functionality for online updates for the IDW software has been removed; the button for this feature has also been removed from the **Maintenance Admin** menu. Local updates are still supported via USB flash drive.

New Features in IDW v1.4

View Thumbnail Mode

Changes the size of the thumbnail to enlarge (zoom in) showing two (2) or three (3) across the console screen, showing more details for easier viewing. You can also reduce (zoom out) the size of the thumbnails to show four (4) across on the console screen.

B&W Mode

A button is available to toggle the images from **Color** to **Black and White (B&W)** and back again as needed. A global setting is also available to change the initial mode of the system to **B&W**.

New Features in IDW v1.3

The v1.3 release adds new functionality that makes the IDW system easier to use than ever.

The new image **Auto-Transfer Mode (Default On)**

While in this mode the system will transfer all the images automatically to the IDW console without any additional button presses on the camera. The operator then selects the images on the console to process and print.

The new complementary setting for the maximum number of image automatically downloaded is provided (**default 16**) of the most recent images on the camera. This enhances the performance of the system.

NOTE: The original DPOF print button mode can still be used by switching the console back to that mode. In the DPOF select mode the images are selected in the camera and the camera **Print Button** is pressed for each image transferred to the IDW console.

Also in this release, a new **Auto-Processing Mode** can be enabled (default **OFF**). When enabled, it will skip the selection screen and automatically process the transferred images. This will allow for true one-click, process, and print operation. Once the image is processed the IDW system will then use the **Auto-Print** setting: **Green**, **Yellow**, or **Off** to control the workflow.

IDW520 System Components

The following components make up the IDW520 system.

- ❖ Digital Camera with SD card slot
- ❖ Wireless SD WiFi card
- ❖ Processor console 7" LCD Touchscreen from PiPO Technologies Co, Ltd.
- ❖ DNP IDW520 ID photo software (loaded on wireless console)
- ❖ DNP ID Photo Printer (ribbon and paper sold separately)

Using the IDW520 system, you can:

- ❖ Make passport or ID photo prints. And depending on the country selected, you can also make visa, resident and citizenship, or other regional or custom photo prints.
- ❖ Edit images to improve the quality of the passport or ID photo.
- ❖ Monitor your printer for errors and low print media warnings.
- ❖ Reprint images in the image gallery.
- ❖ Export the digital files to a USB memory.

IDW520 Console

The IDW520 console is the brains of the system. It communicates between the camera and the ID photo printer. The console receives the images transferred from the ID camera and formats them as passport/ID photos. Message prompts appear on the screen while the image is updated. The console also controls the DNP ID photo printer. It monitors and reports the printer status indications. Use this image to identify all of the necessary ports on the IDW520 console.

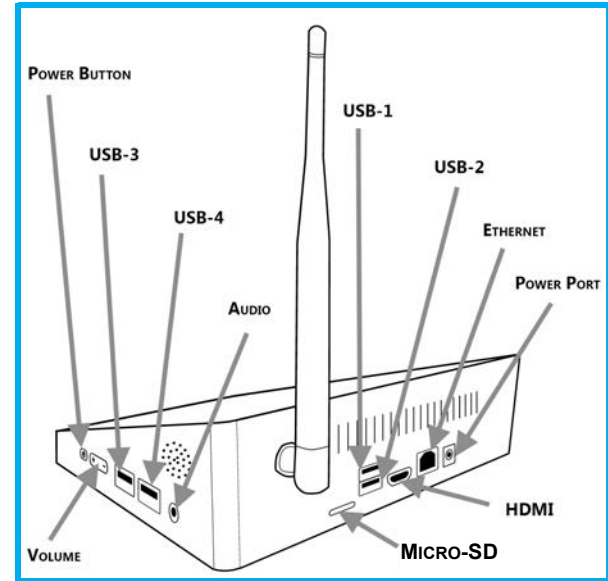

Your Camera Controls

Use the diagram to identify the areas of your passport camera you will use with the IDW520 system. The camera comes set up for operation with your IDW520 system. While there are more settings and functions available on your camera, DNP Imagingcomm America Corporation recommends not changing other settings without first consulting Technical Support. For more information about other settings and camera controls, see your camera user manual.



- ❖ **LCD Viewer:** The large view area on the back of the camera. Use the LCD viewer to preview your passport photos prior to sending the image to the IDW520 console for printing. The head positioning guide on the LCD viewer allows you to take perfectly aligned ID photos every time.

- ❖ **Control Wheel:** The control wheel – to the right of the LCD viewer – is used to access many camera functions. Use the wheel to access menus as well as to move within menus. For the purposes of this document, the ▶ ▲ ▼ and ◀ icons (right, up, down, and left) are used to demonstrate moving within menus. The **SET** button is the button in the middle of the control wheel is used to select the highlighted option.
- ❖ **Menu Button:** Accesses the main camera menu. Use this button to access the camera menu and to set or confirm sending an image to the I send images to the IDW520 console.
- ❖ **Mode Dial:** This dial allows you to select the desired recording mode. The dial should be set to **Red Camera** icon, as indicated in the image to the right. Rotate the dial so the **Red Camera** icon is selected.



Installation

In this Chapter

Preparing the Camera	19
Setting up the QW410-iD Printer	20
Connecting the Printer	20
Installing the Printer Paper	22
Replacing the Printer Ribbon	25
Using the IDW500A Printer.	27
About your Printer	27
Replacing the Printer Paper and Ink Ribbon Print Pack	27
Maintaining the Printer	32
Cleaning the Platen Roller	32
Cleaning the Thermal Print Head	33
Repacking the Printer	36
Troubleshooting Printer Issues	37
Clearing Paper Jams	37
Repairing Damaged Ribbons	38
Setting Up the IDW520 Console	40

Preparing the Camera

1. Unpack the camera.
2. The camera battery must be charged prior to use. Make sure the camera is OFF before charging.
3. Place the rechargeable battery in the battery compartment.
4. Locate the SD Wi-Fi card that shipped with your system in the console box.
5. Install the SD Wi-Fi card in the camera compartment, which is located on the side of the camera. Close the door.
6. For cameras with AA rechargeable batteries, the new rechargeable battery kit has partial charge; it is recommended to charge up the batteries before putting them into the camera for operation.

Note: If the camera is supplied with alkaline batteries, use these only once and then discard them; they are not rechargeable.

For camera with on-board charging, use the supplied cable or use the supplied external battery charger. Use the supplied charging cable and plug it in to charge the battery from a wall outlet. The charging port is located on the right side of the camera under the cover. When the red light appears on the top of the camera, the battery is charging. For more information, see the user documentation that came with your camera.

7. Connect the camera strap and lens lanyard to the camera.
8. Set the camera aside while the batteries charge so that you can set up the rest of your IDW520 system.
9. Once you have set up the other system components and the camera is fully charged, power the camera ON and it will be ready for use.

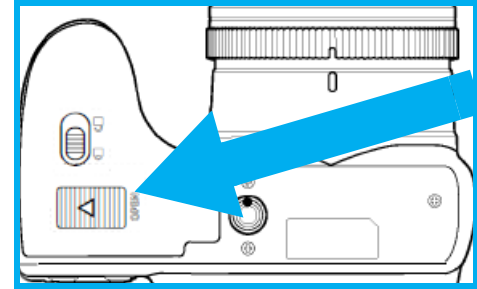

Setting up the QW410-iD Printer

The console has on-board help videos that show how to load the print media, i.e., paper and ribbon. The how to videos for this and other operations can also be found on the DNP website.

Connecting the Printer

ATTENTION:

Save the original box and packaging material! You can store the printer in the box when its not in use. You can also use the box for transporting or shipping the printer.

1. **Unpack your printer.** Remove your new printer from the shipping box. Remove any packaging material (plastic, tape, etc.) from the printer.
2. Verify that you have the following components.
 - ❖ (1) QW410 printer
 - ❖ (1) Paper tray
 - ❖ (2) Paper spools
 - ❖ (2) Paper spool spacers (not used for ID print media)
 - ❖ (1) Printer power cord
 - ❖ (1) USB Cable

NOTE:

You also need a box of ID Photo printer media to use your new printer!

3. **Place your printer in the printing location.** Set your printer on a level, sturdy surface. Placing the printer on an unstable surface could cause the printer to fall, cause you injury, or damage the printer components during printing.

4. **Connect your printer.** Make sure your printer is powered OFF. Connect the power cord to the printer (**blue circle**) and plug it into a wall outlet. Connect a USB cable to the type-B USB port and to the computer (**yellow circle**). Power ON the printer and computer.



Installing the Printer Paper

1. **Prep the new paper roll.** Open the printer media box and remove a roll of paper. Remove the plastic but do not remove the edge seal at this time. Check that the paper edges are flat and are not protruding from the center of the roll. Place the new paper roll on the paper spools. Be sure to press the spools against the paper roll to set the paper tightly against the spools.

ATTENTION:

Also make sure that the paper spacers are removed during initial installation - before placing the roll on the spools.

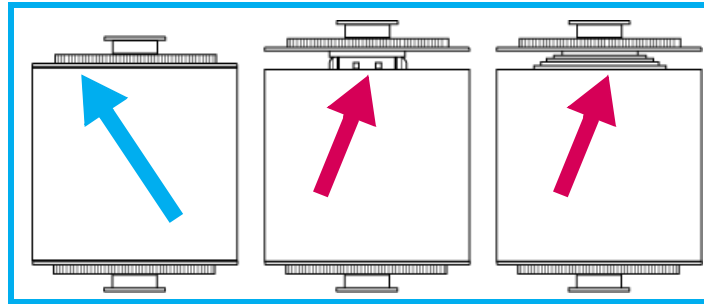

2. **Mount the paper roll onto the paper spools.** Locate your new printer media and remove one paper roll and one ribbon. Make sure the paper roll is oriented so that the leading edge of the paper roll is coming over the top of the paper roll and directed towards the front and bottom of the paper roll.
3. **Set the paper in the printer.** Place the mounted paper roll into the printer paper compartment. Remove the seal on the paper.



4. **Feed the paper into the printer.** Feed the paper so that the paper comes over the top of the roll and into the bottom of the printer paper compartment. Continue feeding the paper until the printer beeps. The ERROR LED changes from flashing red and orange to flashing red.



5. **Replace the scrap bin.** Reset the scrap bin in the printer.

NOTE:

The POWER LED light turns green when the ribbon, paper, and scrap bin are properly installed. If the ERROR LED flashes red, make sure ribbon, paper, and scrap bin are properly seated.

6. **Replace the paper tray.** The paper tray can hold up to 20 prints. However, it is recommended that prints are removed from the tray at regular intervals to prevent jams.

Replacing the Printer Ribbon

1. **Open the ribbon compartment.** Press the button on the top of the printer to open the ribbon compartment.
2. **Orient the Ribbon.** Orient the new ink ribbon so that the supply side (larger side with yellow spool end) is towards you, and the take-up spool (smaller side with white spool ends) is towards the back of the printer.



3. **Place the ribbon in the printer.** Place the left sides of the ribbons onto the printer flanges one at a time. Press the right sides of the ribbons into their holders until they click into place. Remove any slack from the ribbon by rotating the ribbon towards the supply side. Close the ribbon compartment.

NOTE: The yellow ribbon flange is inserted into the yellow holder.

4. **Wait for the blank prints.** With the printer turned ON, the printer will initialize and eject 3 blank sheets of paper. The Power / Ready light will remain lit. The printer is ready to print. If the error light remains lit, recheck that the paper and ribbon are loaded correctly.
5. **Install the paper tray.** The paper tray can hold up to 20 prints. However, it is recommended that prints are removed from the tray at regular intervals to prevent paper jams.

NOTE:

The POWER LED light turns green when the ribbon, paper, and scrap bin are properly installed. If the ERROR LED flashes red, make sure ribbon, paper, and scrap bin are properly seated.

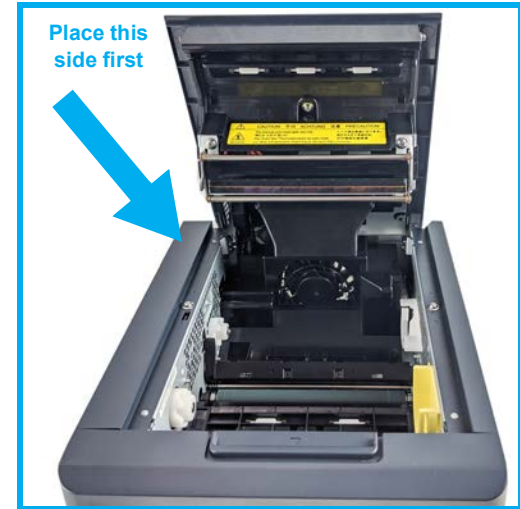

Using the IDW500A Printer

About your Printer

Your ID Photo Printer printer comes with a user manual as well as other documentation should you need in-depth instructions on operating your printer. For daily use, the procedures in this chapter provide basic usage instructions as well as some troubleshooting and maintenance steps.

Be sure to save your shipping box! If you need to transport your printer or send your printer in for repairs, the original shipping box is the safest packing option. Just put the packaging materials (including the print head protection foam block) back in the box and store it in a safe place.

Replacing the Printer Paper and Ink Ribbon Print Pack

If you have questions about how to replace media or perform any printer operations, check your help documents and videos by pressing the ? icon on the console main screen.

Always replace both the ribbon and paper at the same time. Always leave the printer turned ON when changing the print media pack in order for the printer to properly initialize the newly installed print pack. The paper and ink ribbon print pack are sometimes also referred to as the “print media” or just “media.”

1. Remove the print catch tray from the front of the printer and empty the paper scrap box.



2. Press the release lever on the top of the printer to open the media door.



3. Throw away the old ribbon.

4. Remove the paper spool. Take the spool ends off of the spent paper roll and throw away the roll. (Do not throw away the spool ends.)
5. Load your new paper roll onto the spool ends. Make sure that there are no gaps and that the paper roll is not bulging to one side.

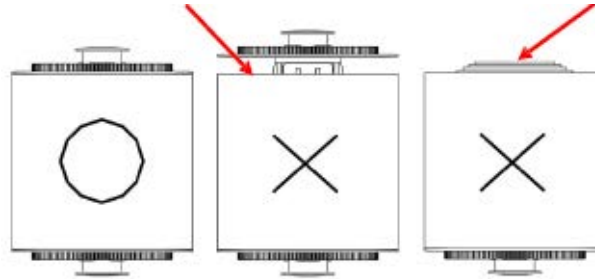

6. Place the paper spool into the printer so that the leading edge of the paper feeds over the top of the roll towards the front of the printer.
7. Remove the PULL tab from the paper roll.
8. Pull the paper towards you about one (1) foot for some slack.
9. Feed the paper between the silver roller and the silver bracket labeled **Insert Paper**.
10. Thread the paper through and guide it down into the black guide plate with the white rollers.

11. Keep feeding the paper by hand until the printer beeps. Once the printer beeps, the paper is loaded. The paper will complete the loading process when the door is closed.

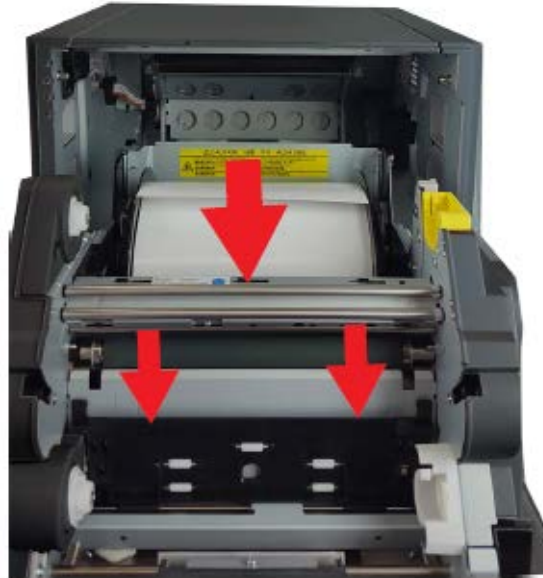

[Refer to the Help button on the IDW500 console for a video demonstrating the print media loading process.](#)

12. Set the ribbon supply side (two white ends) in the lower, or front, brackets.

13. Set the take-up side (one white and one yellow end) in the upper, or back, brackets. Insert the left side of the ribbon spool into place first, then snap the right side of the spool into place.
14. Wind the take-up spool to remove any slack in the ribbon. The supply spool feeds over the top while the take-up spool feed underneath.



15. Close the printer media door. Five blank prints are ejected.
16. Replace the scrap box and the print catch tray.

Maintaining the Printer

Cleaning the Platen Roller

Only use the pre-saturated wipes from this kit. Avoid sharp edges when cleaning the printer. You should only clean the platen roller if you are instructed to do so by technical support.

1. Clean the platen roller if you experience soft, blurry lines on your prints that run in the same direction of the print feed.
2. Release the open lever and open the front cover.



3. Remove the ribbon tray and set it aside.
4. Remove the paper spools and set them aside.

5. Using the pre-saturated wipes that you received in your cleaning kit, wipe the platen roller while rotating the roller slightly. Use a clean portion of the wipe for each swipe.



6. Wait at least 3 minutes for the roller to dry, then replace the paper and ribbon.
7. Close the printer securely and wait for the printer to initialize.

Cleaning the Thermal Print Head

You must wait a minimum of 5 minutes before cleaning the thermal head to avoid severe burn injuries. Never use water to clean the thermal head. You should only clean the print head if you are instructed to do so by technical support.

Clean the thermal head if print quality has decreased and/ or you see hard lines in the middle of prints. Always clean the platen roller first.

1. Release the open lever and open the front cover.



2. Remove the ribbon tray and set it aside.
3. Remove the paper spools and set them aside.

4. Locate the thermal head in the printer chassis. Look for the line where the orange and black strips meet on the head.

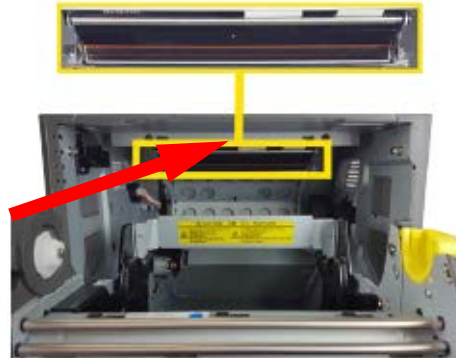

5. Using the cleaning pen, swipe the thermal head in a side to side motion. Clean the entire length of the thermal head.
6. If you see dirt or debris on the thermal head, use the thermal head wipe to clean only the dirty portion of the thermal head.
7. Wait at least 3 minutes for the head to dry, then replace the paper and ribbon.
8. Close the printer securely and wait for the printer to initialize.

Repacking the Printer

To transport the printer, repackage the printer with the original packaging material. Failure to do so will void any warranty. If the original packaging materials are not used or the printer is not packed correctly, the printer may be broken during transport. Always save the print head protective foam. Do not throw away any packaging as it is needed to safely transport the printer.

Remove all accessories, media, and attachments from the printer – this includes all the ribbon, paper roll, and paper spools as well as the USB and power cables. Place the accessories in the accessory box.

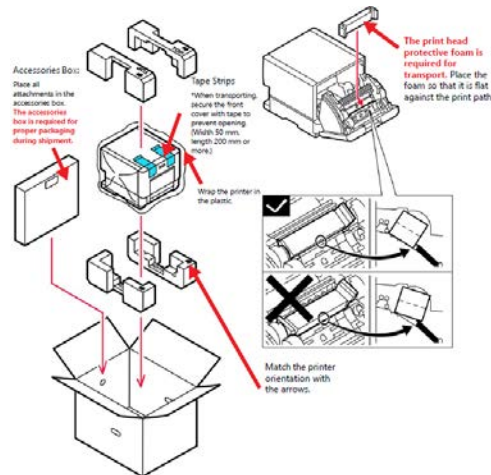

Troubleshooting Printer Issues

Clearing Paper Jams

1. Open the printer media compartment using the release lever on the front of the printer.
2. Remove the ribbon.
3. Carefully pull any remaining paper from the paper path.

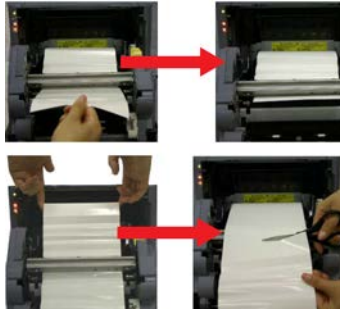

4. Cut the paper and remove the paper roll from the printer.

5. Cut the paper roll to remove any wrinkled or bent paper from the roll. Printing over bent paper can damage the printer and cause more paper jams.



6. If the paper is not cut evenly, it may cause abnormal printing and or the paper to jam. Re-feed the paper as you would when loading a new paper roll.

Repairing Damaged Ribbons

1. Remove any ribbon remaining in the printer.

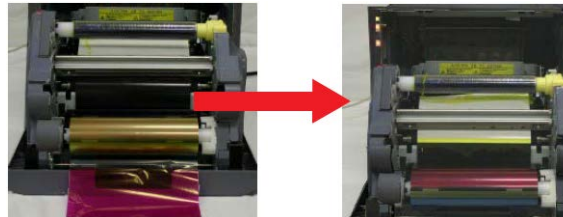

2. Remove any incomplete or jagged ribbon panels.

3. Use clear tape to reattach the two ribbon spools.



4. Replace the ribbon in the printer and wind the ribbon a few times to remove any slack and until the tape is no longer seen.



5. Close the media compartment.

Setting Up the IDW520 Console

1. Unpack the console from the shipping box. Remove any protective plastic sheeting, packaging materials, or foam from the processor console.
2. If you haven't already done so, locate the SD Wi-Fi camera card in the console packaging. Set it aside for camera set up.
3. Plug the power cord into the IDW520 unit and into a wall outlet (see illustration to the right).
4. Plug the printer USB cable into the rear bottom port on the back.
5. Plug the power cord into the console power port and into a wall outlet. Do not power on the processor console at this time.

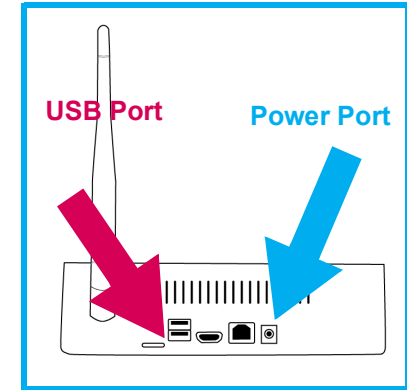

Using the IDW520 System

In this Chapter

Turning ON the System	43	ID Photo Template	61
Operating the IDW520 System	44	Using the Thumbnail Image Gallery	62
Take a Passport Photo	44	Using the Operations Bar	64
Transfer the Image	48	Editing Images	65
Auto Image Transfer Mode (new in v1.3)	48	Reprinting an Image	68
DPOF Transfer Mode	49	Auto-Transfer Mode	68
Print Button Location for IDW Camera	50	Reprinting an Image (continued)	69
Image Transfer Selection Gallery	52	DPOF Transfer Mode	69
Image Thumbnail View Mode	53	Importing Images via the USB port	70
Print the Image	54	Image Processing	72
Saving Images to a USB Drive	58	Changing the ID Photo Template	73
About the ID Photo Dashboard	59	Printing Full Page Photos	75
Understanding the Status Bar	60	Deleting an Image from the Camera	76
Printer Icon	60	Deleting all Images on the Camera	77
Camera Icon	61	Using the Flash	78
Software Version	61	Adding a Custom Template	79

Printer Queue 82

Turning ON the System

You must power ON the system in the following order:

1. **Printer** (wait for the ready light on the front of the printer before continuing).
2. **IDW520 Console.** The power button is on the right side (wait for the ID Photo application to appear and the Power On Self Test (POST) print before continuing. To turn it on, press and hold in the power button for a few seconds; when the red power light comes on, release the power button.

NOTE:

Be aware that if the date and time on the console are set prior to 2018, images will **NOT** be transferred/printed. For instructions on setting the date and time, see “System Section” on page 97.

3. **Camera** (when the IDW520 console beeps and displays a **CAMERA CONNECTED** message, the camera has been recognized as connected to the network). It can take a minute for the system to recognize the camera.

NOTE:

If you hear a beep after starting the system, check the console for an error message. Typical error messages are **PRINTER NOT FOUND** (verify the printer is ON and plugged into the IDW520 console) or **MEDIA MISMATCH** (either no media or the wrong media is loaded in the printer.)

Operating the IDW520 System

Start to finish, here's how to take a picture, transfer it to the system, and print the photo.

Take a Passport Photo

NOTE:

The IDW520 can also be used to take photos for visa, citizenship, other regional or custom IDs, and permanent residency documents, depending on the ID template you have selected on the dashboard. A custom template can be created on the IDW; [see the “Adding a Custom Template” on page 79.](#)

1. If you haven't already, power ON your system in the following order: printer, IDW520 console, and then the camera. Watch the console screen for the **CAMERA CONNECTED** message. This message lets you know the system is ready for use.

- Place the subject in front of a white or very light colored, plain background with no textures or patterns. Use a flat white screen for the image background. A glossy or reflective screen can cause issues with the flash. If possible, use a screen that is at least 36 inches wide and 48 inches tall.

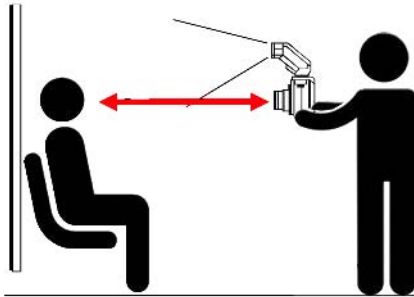

Distance from camera to subject
 - more than 4 feet (1.25 meters)
 - include upper body and space above head in viewfinder

Approximate size picture using LCD display panel on digital camera



When using tall ID templates, e.g. Canada passport, always keep the subject's head well within the guide oval for better image framing results.

NOTE:

Confirm the Mode Dial selector is properly set. DNP recommends the Red Camera icon fully automatic mode setting.

- Have the person stand (or sit) close to the background to minimize shadows. With indirect side-lighting it may be better for the subject to stand further away from the background to minimize shadows.
- If possible, use photo lights to properly illuminate the subject and further reduce shadows. If necessary, use the camera flash to reduce shadows.
- Stand 6 feet away from the subject. Hold the camera so that the camera lens is eye-level with the subject.



- Center the subject's head using the head positioning guide on the LCD screen. The head should fit within the oval as much as possible without going outside of the line.



- Align the top of the subject's head with the top edge of the oval. Use the zoom function to line up the subject's chin with the bottom edge of the oval.
- Take the picture by pressing the shutter button. Pressing the shutter button slowly allows the camera to automatically focus on the subject.
- Review the photo on the camera LCD. Verify that the subject's head fits within the face guides.

NOTE:

The FZ80 ID Photo camera has a zoom memory function. This time-saving feature will automatically bring the zoom back to the same position when you turn it on for successive picture taking sessions.

10. ❖ For most government ID photos, e.g. US passport, the following requirements apply. Check local requirements for other ID templates.
 - ❖ Taken with the subject's full face showing towards the camera.
 - ❖ Taken with a neutral facial expression (preferred) and with both eyes open.
 - ❖ Taken in clothing that the subject would wear on a daily basis:
 - ❖ Uniforms, clothing that looks like a uniform, and camouflage attire should not be worn in photos except in the case of religious attire that is worn daily.
 - ❖ The subject may only wear a hat or head covering if they wear it daily for religious purposes. Their full face must be visible and any head covering cannot obscure the hairline or cast shadows on the face.
 - ❖ Eyeglasses are not accepted unless needed for medical reasons (medical certificate may be required).
 - ❖ Headphones, wireless hands-free devices or similar items are not acceptable in the photo.
 - ❖ Use the following guidelines when taking passport photos:
 - ◆ Place the subject in front of a white or off-white background with no texture or pattern.

Tech Tips:

When taking photos for a tall rectangular template, the IDW system will crop and resize the image as needed. The camera can be rotated 90 degrees to shoot in the portrait orientation for better image definition with certain limitations.

Be sure the camera aspect ratio is set to 4:3 or similar rectangular setting.

When the PixPro AZ255 or Sony H300 camera are used in portrait orientation, the image file must be manually rotated in the camera menu for the IDW system to process it properly. Photos taken with the FZ80 camera and other cameras that tag the image orientation do not need to be rotated in the camera, the system handles them automatically in either orientation.

The center mark of the camera LCD in most cases should be at eye level or centered on the bridge of the nose. Always keep the subject's head well within the guideline oval to ensure there's enough whitespace surrounding the subject for the IDW processor to format and crop it into the ID template.

Transfer the Image

Auto Image Transfer Mode (new in v1.3)

The Auto-Transfer Mode function will transfer all the images taken on the IDW camera automatically to the IDW processing console once they are shot. In this mode, the operator can simply shoot the ID photo and it will automatically transfer to the IDW processor console. On the console you select the image for processing and printing.

NOTE: When Auto-Processing is also enabled, it will automatically select all the transferred images to process and print the images in the selected template.

The Auto-Transfer Mode simplifies the image transfer operation, avoiding unnecessary button presses on the camera. The images transferred in this mode will automatically appear in the IDW console image gallery. Here they are ready to be selected for processing. This is the new default factory set mode.

The companion feature, found in the **Settings** menu, allows auto-processing of the images after the auto transfer occurs. The default for auto-process in the auto-transfer mode is set to **OFF**, allowing the operator to manually select the images in the gallery and accept only the desired images for processing. Other images will remain in the gallery and FIFO (first in, first out) up to the image gallery image limit. The default gallery image limit is 16 images, up to 24 images.

The original camera DPOF image select and transfer mode is still available and can easily be switched to in the **Settings** menu.

NOTE: All images should be deleted from the camera card and image queue each day. This will maintain the performance of the system and ensure customer privacy. Please see “**Clear Images Queue**” on page 125 for instructions.

TECH TIP: The v1.3 Auto-transfer mode is available upgrade for all operators with the IDW520 systems and ez-share WiFi card. It is not available for older IDW500 consoles, or systems with the FlashAir WiFi card.

DPOF Transfer Mode

NOTE:

For best results, send only one image at a time from the camera to the IDW520 console.

1. Once you've taken the passport photo press the **PLAYBACK** button to verify that the photo meets the ID photo requirements.
2. If you took multiple pictures, you can scroll to the best image.
3. For best results when transferring the image to the console, have your camera no more than 15 feet from your IDW520 console during the transfer process. Placing the camera closer to the console is better when transferring the image.
4. Once you have located the image you want to print, in playback mode, press the print button on the top of the camera. For the Lumix FZ80 camera, press the **Fn2 (print)** button. For the PixPro AZ255 camera, press the continuous shoot button.

- The print menu option appears. Check that the print quantity is set to **1** and press the **SET** button on the camera to transfer the image to the IDW520 console.

NOTE:

The **SET** button is the center button on the control wheel on the back of the camera.

Print Button Location for IDW Camera

Used only with DPOF image selection mode.



*PIXPro AZ255 continuous
shoot button*



*Lumix FZ80 Camera
Fn2 activated DPOF
button*



*For DPOF print action, use Sony
camera Menu button*

6. Immediately return the camera to shooting mode by pressing either the **SHUTTER** or the **PLAYBACK** button.

ATTENTION:

Do not leave the camera in playback mode. Also note that if multiple images are transferred, the images take longer to process.

The image queue can hold up to 16 images. The oldest images are deleted from the gallery as new images are transferred.

Image Transfer Selection Gallery

When transferring images to the IDW console using the **Image Auto-Transfer Mode**, or when importing images from a USB device, the images will appear in the **Image Gallery** ready to be selected for processing. Touch to select the images to process and print; then touch the **UPLOAD** button.

NOTE: The **Image Gallery** will display the 16 (default) most recent images.

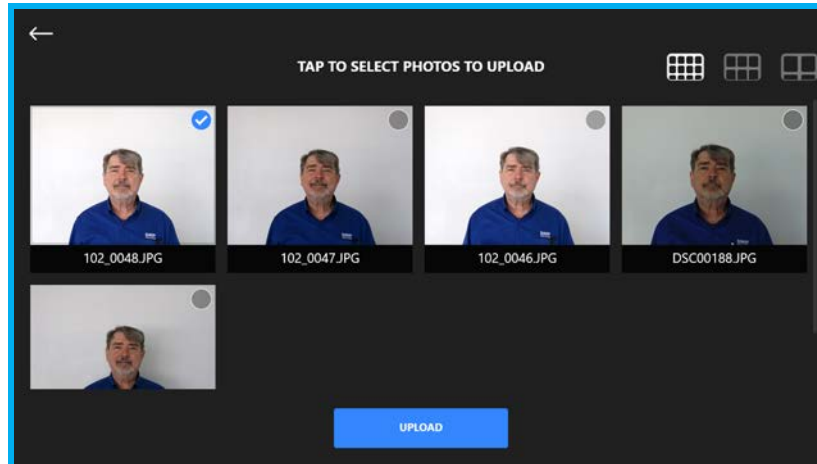
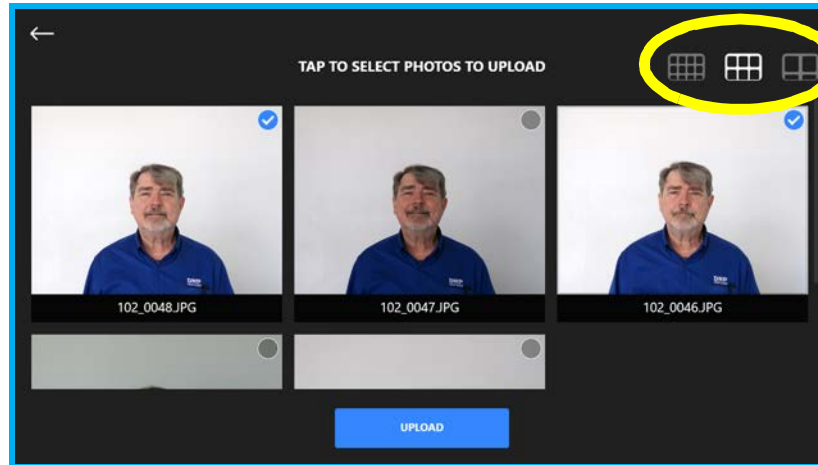

Image Thumbnail View Mode

The **Image View** icons are used to change the size of the thumbnail images. Touching the icon will change the view to enlarging (zoom) the thumbnails for easier viewing the image selection. The choices are to view thumbnails as 4-across, 3-across or 2-across the console screen. The setting is sticky, remaining at the last chosen setting.



Print the Image

1. The image begins to transfer and a **DOWNLOADING IMAGES** message appears on the console screen. You'll also see a box with *Processing Images* shown as the thumbnail is prepared. The thumbnail appears in the thumbnail section of the home screen.

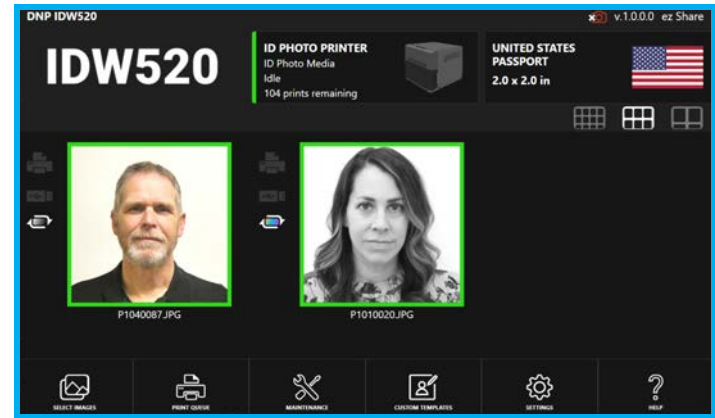
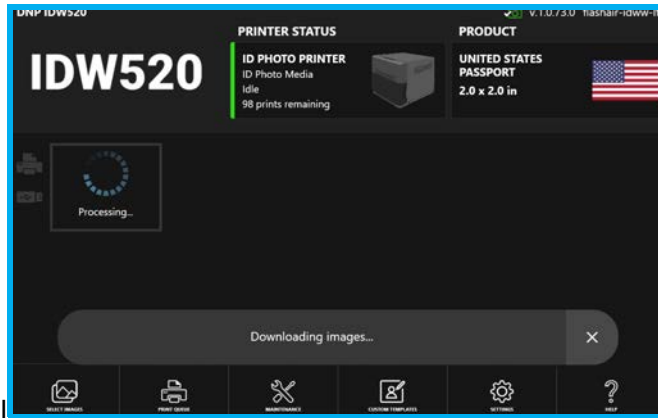

2. If the image has a GREEN box around it, the image will likely meet the requirements for that template. If the image has a red box, it will not meet the requirements for that template.

If the image has a YELLOW box, it has met some requirements, edit the image to review and correct, or retake the image.

When a RED box surrounds the image, it most likely will not meet the requirements for that template. Retake the photo of the subject.

3. Tap on the **image thumbnail** to open the image results screen. On the image review screen you can continue to print the image, delete it, edit it, or copy it to a USB drive.
4. If the image meets the requirements (you'll see a green box around the image), you can press the **Print Preview** button. If the image does not meet the printing requirements (red box), you can try to edit the image or simply delete and retake the image.

NOTE:

The processor console is factory set to Auto-Print images. The Auto-Print setting can be changed to Auto-Print GREEN only images, or GREEN and YELLOW Images, or Auto-Print can be disabled. The configuration for this feature is in the Settings menu.

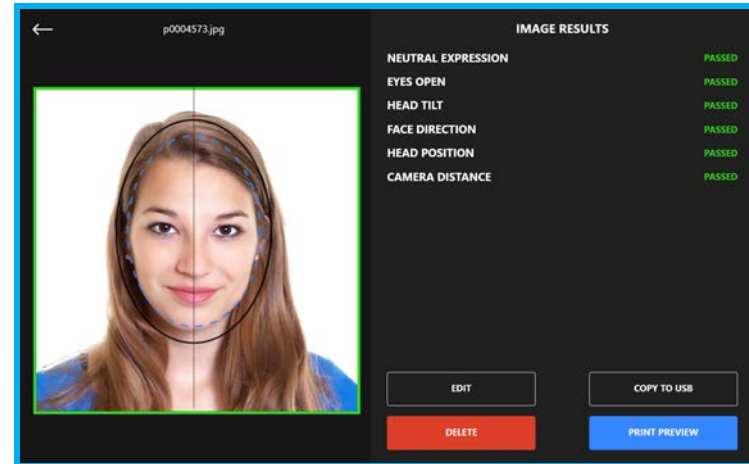

5. Press the **PRINT** button to print your image or press the **COPY TO USB** button to save your image to a USB drive. Press the **PRINT & COPY TO USB** button to do both. You can also increase the print quantity by pressing the **PRINT QUANTITY** buttons; the default is set to one (1) but you can print up to five (5) copies.

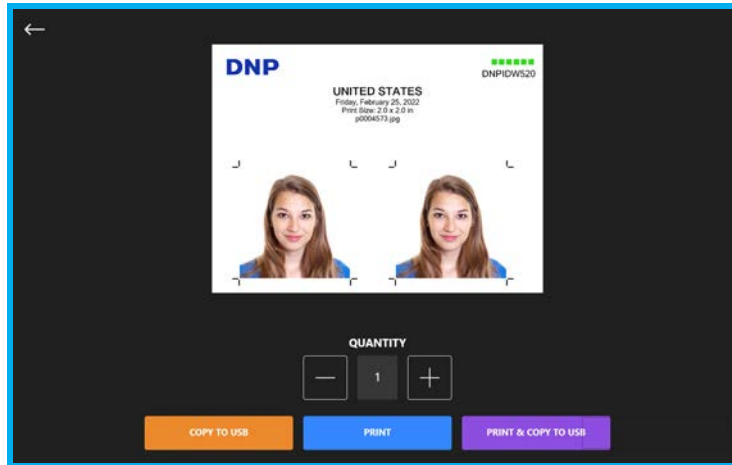
**NOTE:**

The **COPY to USB** button will export the original image JPG file on the USB along with processed and cropped images of the active template in both JPG and PNG image format. Changing the camera setting to increasing the image size will transfer a larger image and also increase the resolution and size of the image files exported to USB. This is necessary for certain government requirements for higher resolution image uploads. Using larger input image files will also result in longer IDW520 processing times.

When using the **Copy to USB** function with the **US Passport** template, an additional file will be exported to the USB. The additional saved image is processed by the IDW system and sized to be used for **US Passport Online Renewal** process while using the US State Dept. online image upload process. The improved file name is annotated with **PXXXX** for **Digital Upload.JPG**.

6. A **USB MEDIA READY** message is shown just before the images are transferred to the USB media. Three images are saved to the USB drive – the original image that was taken on the camera, and the two copies of the edited image; one copy as a JPG format and the other is PNG format.
7. When the images have finished transferring to the USB drive, the console displays a **REMOVE USB MEDIA** message.

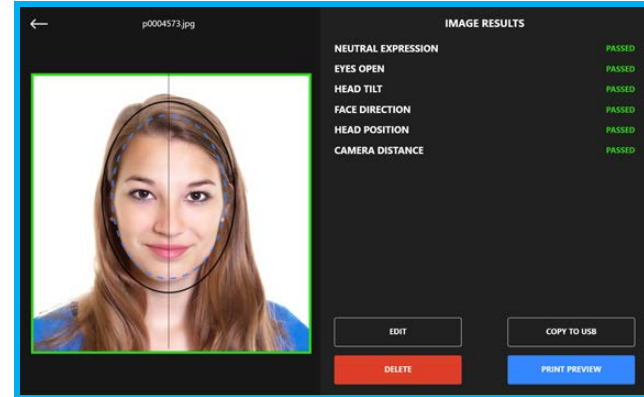

Saving Images to a USB Drive

Once you have sent an image to the IDW520 console, you have the option of saving the image to a USB drive.

1. Insert a USB drive into the console USB-4 port. It is recommended to plug the USB drive into the USB-4 port.
2. Take and send your image to your console.
3. Tap on the image in the thumbnail queue to open the image results screen.
4. On the image results screen, press the **COPY TO USB** button.
5. When the confirmation message appears select **YES**.

If you have not inserted a USB device already, your console gives you an **INSERT USB MEDIA** message. Do not remove the USB drive until you are instructed to do so later in this procedure.

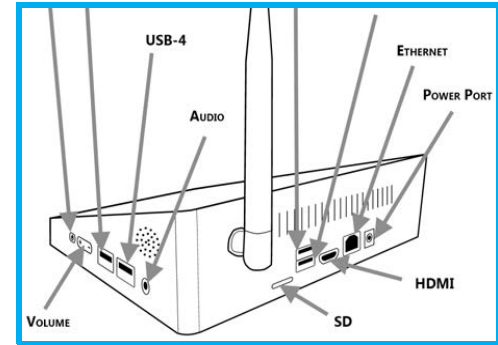

About the ID Photo Dashboard

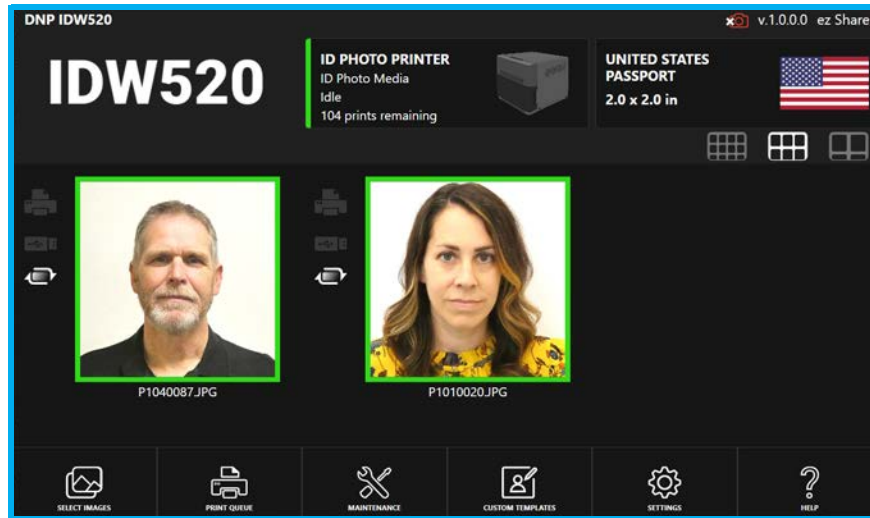

The IDW520 dashboard (or home screen) gives you an overview of your system health and operations and also displays any photos that have been taken during the current IDW520 work session. The screen can be divided into three sections: the health bar, the thumbnail section, and the systems operations bar.

Understanding the Status Bar

Along the top of the screen you'll see the status bar that displays your printer icon, camera connection icon, software version, and current ID photo template.

It's a good idea to review the status bar before you use the system to make sure you're ready to process and print an order!

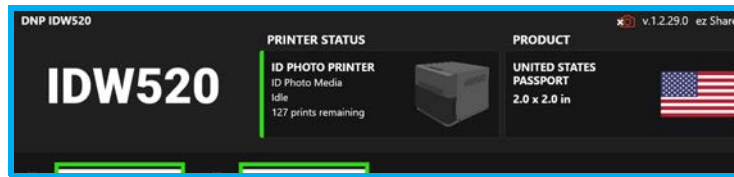

Printer Icon

Your printer icon gives you an overview of your printer status. From this icon, you can see:

- ❖ The type of media loaded in the printer.
- ❖ The number of prints remaining on the media.
- ❖ The printer status (idle, waiting, printing, error).

The colored bar on the side of the printer icon gives you an idea of your printer status.

- ❖ Green: The printer is ready to print or currently printing.
- ❖ Yellow: You need to replace the printer media soon.
- ❖ Red: There is an issue with the printer that you must address before you can print.

Camera Icon

The camera icon is either green (camera is connected and ready to use) or red (camera is not connected).

Software Version

The software version is displayed next to the camera icon.

ID Photo Template

The template that is loaded is displayed at the far right edge of the health bar. By clicking the icon, you can change the template. Some of your template choices are:

- ❖ Passport templates for various countries.
- ❖ Visa templates
- ❖ State or providence templates
- ❖ Resident templates
- ❖ Citizenship templates
- ❖ Custom templates

For some ID templates a higher resolution image is recommended to meet the government requirements, particularly for image files that will be exported for digital upload. The camera resolution can be increased when this ID photo is taken. Camera capture size will correlate to the processed export file size.

- ❖ The camera setting should be returned to the original image size for normal ID operations.
- ❖ Longer processing times will occur with larger image files.

Using the Thumbnail Image Gallery

Printer icon

USB icon

B&W button

Color frame around image

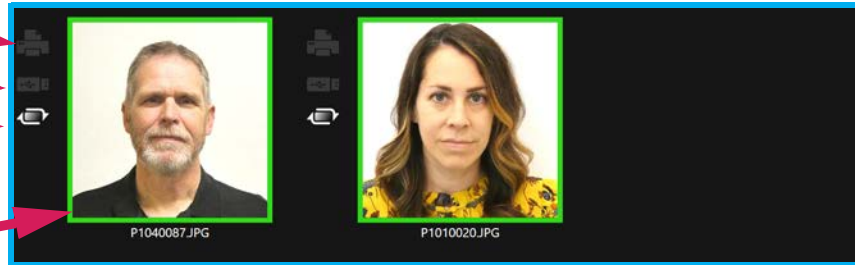

- ❖ View images from your current work session in the thumbnail section. A colored box appears around each thumbnail. The frame around the image shows the results of the biometric check: GREEN - YELLOW - RED - PURPLE
- ❖ When the frame box is GREEN, the image has passed the checks and is a good image for ID photos.
- ❖ If the box is YELLOW, there may be a minor issue with the photo, and you need to review the photo carefully before submitting it for printing. If the box is RED, the image will probably not be accepted for ID photos. The PURPLE box indicates the manual edits have been made by the operator, overriding the automatic on-board results.
- ❖ The **Printer** and **USB** memory icons near the images are gray-out until the action has occurred.
- ❖ The **Printer** icon indicates the image was printed.
- ❖ The **USB** memory icon indicates the image was exported to external USB memory device.
- ❖ The **B&W** mode button will toggle the image between **Color** mode and **B&W** mode.

Touching the image will open the EDIT and REVIEW window. After an image is manually edited, the thumbnail will show a PURPLE frame around the image.

Beside each image are two icons - a USB drive and a Printer icon. The Printer icon indicates the image was printed. The USB icon indicates the images were Exported.

Once the print order has been processed, the icon will highlight to show you which product was produced. Tap on an image to open the preview screen. For more information on previewing and printing images, see “Operating the IDW520 System” on page 44.

NOTE:

The Image Gallery can hold up to 16 images. When the next image is transferred in, the oldest image will be removed from the gallery.

Using the Operations Bar

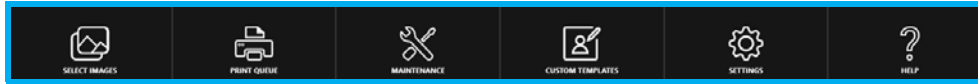

At the bottom of the dashboard, the Operations bar allows you to perform various software, maintenance, and print functions as well as view the help information.

Use the operations bar to access:

- ❖ **Select Images:** Opens the **Image Selection Gallery** to view and select images to process and print. The **Select Images** button is only available in **Auto-Transfer** mode.
- ❖ **Print Queue:** View the completed and pending photos for the current work session. You can also see if any images failed to print. For more information “Printer Queue” on page 82.
- ❖ **Maintenance:** Access your maintenance tasks such as installing updates, activating technical support control, clearing the image queue and restarting the console. See “About the Maintenance Screen” on page 98,
- ❖ **Custom Templates:** View and select the currently loaded custom templates for printing.
- ❖ **Settings:** Change software settings such as language, time, date, etc. in this section. See “About Administrative Actions” on page 91.
- ❖ **Help:** Access helpful documents such as your up and running guide and user guide. You can also view videos about common functions.

Editing Images

The editing screen allows you to make minor color, tone, and rotation corrections to an image.

ATTENTION:

Only edit images if it is absolutely necessary. For optimum system operation, capture the best image possible with the camera rather than edit the image. Proper subject lighting is the key element to achieve good results.

1. On the image results screen, press the **EDIT** button.

ATTENTION:

IMPORTANT NOTE ON EDIT CONTROLS: The color adjustments made on this edit screen are only for the current photo. To make a change that is applied to all photos, use the **SET DEFAULT COLORS** button to save your changes and apply them to future images automatically. This applies to all incoming photos processed even after powering off or restarting the console. Pressing the **RESET** button in the edit screen will return the color controls to neutral. Resizing adjustments are not saved.

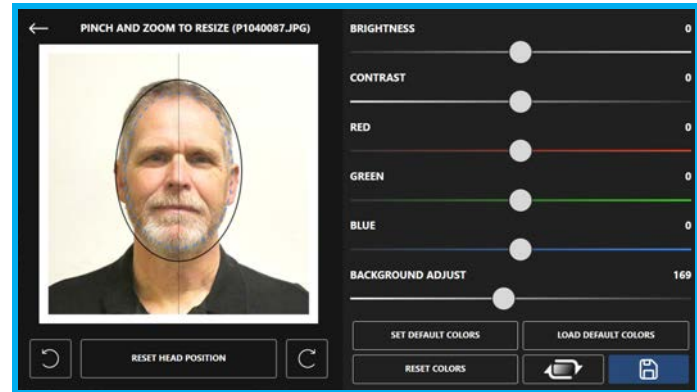

2. Use the editing screen to make the following changes:
 - ❖ **Background Highlight Control Adjust:** The IDW system will automatically evaluate and adapt the highlights to achieve an optimally light face and background for each image. Use this control to override the automatic setting. Slide the control to lighten or darken the background of the image. The results of the auto-adjust processing may be less than optimal when the image lighting is not ideal. A lower numeric value lightens the image background and image highlights, a higher value darkens it. Adjustment Range 100~255.

Tip

When the processed image is too dark or too light and cannot be easily adjusted by the system or manual controls, retake the photo with better lighting. Refer to the troubleshooting section of this guide or contact DNP support.

- ❖ **Color Correction:** If the color is slightly off, correct it using the color sliders. Keep in mind any color correction done will affect the background of the image. Also, make sure your corrections do not distort the skin tone of the subject.
- ❖ **Brightness/Contrast:** Correct the overall tone of the image using the brightness and contrast settings. Again, take care to not change the skin tone or the background of the image.
- ❖ **Rotation:** You can make small rotation changes to the image using the left and right rotate buttons below the image. Press the **RESET HEAD POSITION** button to remove all rotation changes.

NOTE:

To save the changes you have made to the color settings for use with all subsequent photos, press the **SET DEFAULT COLORS** button. To remove all color corrections you have made (including default settings) to this image, press the **RESET COLORS** button. To reload a previously set default color setting, press the **LOAD DEFAULT COLORS** button.

- ❖ **Black and White:** Toggles the current image between **B&W** and **Color**.

3. If needed, adjust the size of the image - use your finger to **pinch and zoom** (as you would on a touchscreen device like a smart phone) the image to resize the image to fit within the guides.
4. Make any adjustments that are needed to the image. The **vertical line** going down the middle of the image is used to center the subject in the template.
5. When you have finished editing the image, press **SAVE** button to return to the image results screen.

Reprinting an Image

Auto-Transfer Mode

When in Auto-Transfer mode, access the **Select Image** button to see the most recent images sent from the camera. Select and upload the image to have it processed and printed.

Select one of the images from the image gallery on the console main screen. Just touch the image you want to reprint and then follow the steps in the previous sections to edit or print the image.

The system will transfer and show the most recent images. When the image for reprint is older and still on the SD card, you can delete the newer images from the card to allow the older images to transfer to the console image section gallery.

<continued on next page>

Reprinting an Image (continued)

DPOF Transfer Mode

When in DPOF image transfer mode :

1. On can camera, clear the DPOF print flag form all old images.
2. On the IDW console access the **Maintenance** menu. Then tap the **Clear the Image Queue** button, which will delete any images in the IDW console image gallery.
3. Now, simply enable the DPOF print flag for the image(s) to resend to the IDW console. This will resend the image from the camera. Following the steps in section “Transfer the Image.”
4. After the images have transferred, process and print as needed.

Importing Images via the USB port

Images from other sources can be uploaded for processing and printing with the IDW520 system. Using the USB-4 port, you can transfer images for printing -- connect either your camera via USB cable, or use a USB flash storage drive.

1. Make sure the IDW520 is working and that the main dashboard is displayed. If you are transferring images from the camera via USB cable, make sure the camera is powered ON.
2. Plug the USB drive or USB cable into the port on the side of the camera and into the USB-4 port on the side of the console. After a few seconds, the IDW will recognize the external storage device and begin to display a thumbnail of the images that can be selected.
3. The IDW520 will display only the first 16 images on the storage device. Any or all 16 images can be transferred at one time. Remove and reload the USB with other images to print more from the external source.
4. When the images are displayed, tap the images you want to upload to select them. Then please the UPLOAD button on the screen.
5. The images will be uploaded and processed for the selected template as if they were transferred from the IDW camera.

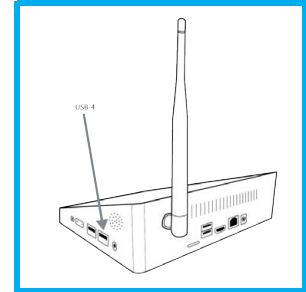

NOTE:

An image size of 5k x 5k is the maximum pixel size accepted by the IDW520

Large file sizes will affect the processing speed of the IDW system. The Image Queue should be cleared of the largest images to avoid slow processing of subsequent ID images.

- Once plugged in, the last images are displayed on the screen.

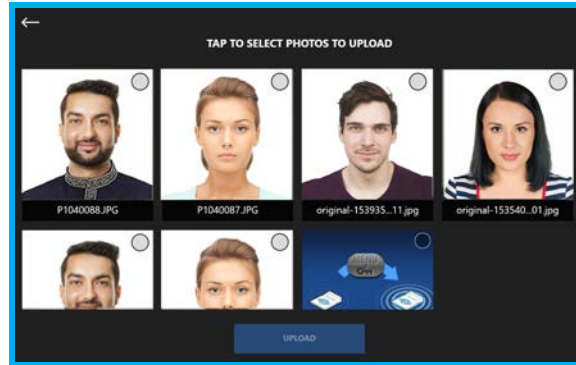

- Select your images and continue printing as you normally would.

Image Processing

On the image printout representation, you notice a series of six (6) colored squares in the upper corner. Each box refers to one of the imaging processing requirements each image must pass. If a particular requirement was met, the corresponding box appears Green. If a requirement was not met, the corresponding box appears Yellow. The processing requirements are as follows:

- ❖ Neutral Expression
- ❖ Eyes Open
- ❖ Head Tilt
- ❖ Face Direction
- ❖ Head Position
- ❖ Camera Distance

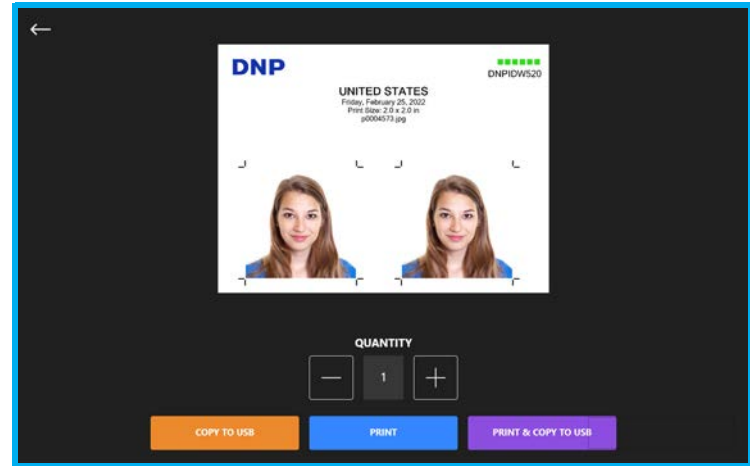

Changing the ID Photo Template

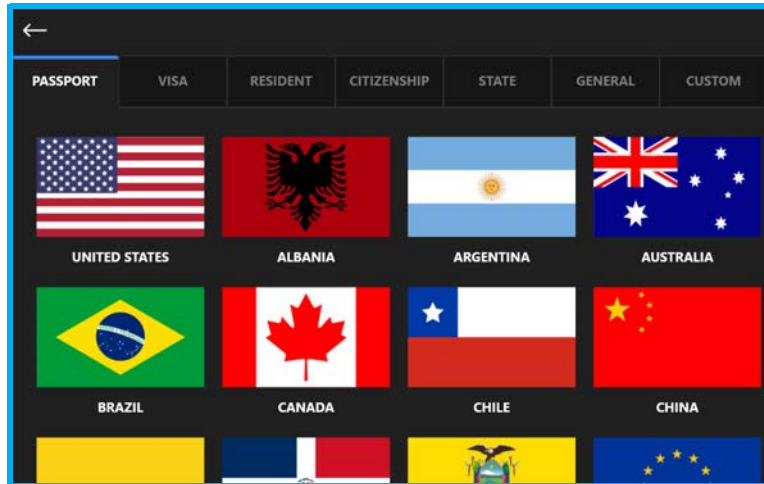

1. From the dashboard (or home screen), tap the **template icon** on the top right side of the screen.
2. When the template selection section opens, use the tabs at the top of the screen to select the **type of template**.

3. Select the template from the listed options.
4. You're returned to the dashboard and the new template icon is displayed. Any images transferred to the IDW520 console will now be cropped according to the new template parameters. Any image already in the image gallery will also be re-processed and reformatted to the new template.

NOTE:

The template sort order will change with system use so the most used templates will appear at the top of the list.

The IDW520 also supports full page image printouts. The Full Page template is found in the **General** tab and can be used for Non-ID photo printing. This function will bypass the bio-detection step and go directly to processing. It will resize the image to fill the entire page, center crop, and allow the operator to edit the image similar to the ID workflow.

TIP:

When printing large image files, in the full page template for example, it is best to clear the console image queue before switching back to an ID template.

Printing Full Page Photos

The IDW520 also supports Full Page image printouts, used for Non-ID photo printing. The Full Page 4x6 template is found in the **General** tab. This function will bypass the bio-detection step and go directly to processing. It will resize the image to fill the page, center crop, and allow the operator to edit the image similar to the ID workflow.

NOTE:

After printing large image files using Full Image mode, it is recommended to clear the Image Queue prior to switching back to a regular ID template in order to avoid long processing times.

Deleting an Image from the Camera



1. On the camera, press the  (DELETE) button on the back panel of the camera.
2. Select the image you want to delete and then press **SELECT** button.

ATTENTION:

DO NOT format the SD card to delete the images. The card programming for the system will be lost if you format the card. See “SD Card Utility” on page 103 if the SD card becomes damaged or formatted.

Deleting all Images on the Camera

The images should be deleted from the camera storage on a daily basis. This is easily accomplished using the Trashcan button on the back of the camera.

1. On the camera, be sure that you are in **PLAYBACK MODE**  (play button).
2. Press the  **Delete** button (trashcan button).
3. Select the **Delete All Images on this Date** option and press the **SET** button.
4. You can also select the **Delete Multiple** or **Delete Single** options.

Using the Flash

The flash is automatically enabled at the factory. Use the camera flash if needed to increase the quality of your photos. Using the flash is recommended as a last resort to brighten photos. Due to passport/id photo requirement, off-camera lighting is best to properly light the subject.

NOTE:

For more information about enabling the flash, see your camera user manual.

1. Press the **FLASH** button on the back of the camera to open the flash hood and use it.

NOTE:

If your images are consistently dark and do not show the necessary details of the subject's face (under exposed, too many shadows, unable to clearly see details), changing the exposure compensation can help correct the issue. You can make this change by pressing the **BACK (Q.Menu)** button and scrolling to the desired option.

Adding a Custom Template

You can create and save a custom passport or ID template. You can select whether an image appears 2 or 3 times on the print out. You can also set the image size to inches or millimeters, as well as setting the position of your image within the template. Once the template is saved, you can use it over and over again!

1. From the main screen on your console, touch the **CUSTOM TEMPLATE** button.

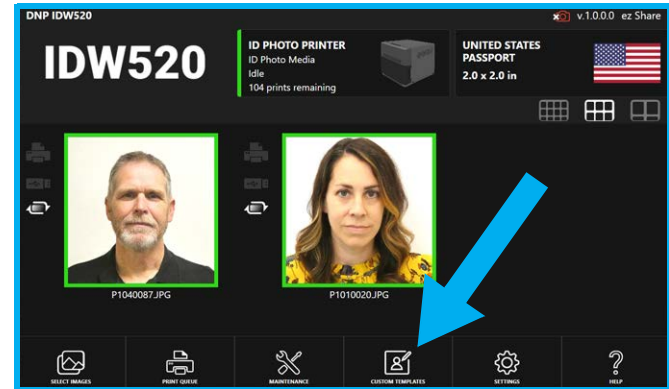

2. Set the **Layout Type**. This allows you to display the image 2 or 3 times on the print out.

CUSTOM TEMPLATE	
LAYOUT TYPE	2
MEASUREMENT TYPE	Inch
NAME	Test
WIDTH	2
HEIGHT	2
MAX TOP OF HEAD	0.3
MIN TOP OF HEAD	0.5
MIN BOTTOM OF CHIN	1.4
MAX BOTTOM OF CHIN	1.7

DELETE SAVE

If you select to have three (3) images on your template, you are limited to an image size of 40 millimeters by 40 millimeters.

3. Select the **Measurement Type**. This can be set to **millimeters** or **inches**.
4. Type the **Name** of your template.
5. Set the **Width** and **Height** of the final printed image.

6. Enter the max/minimum head and chin entries. The maximum and minimum values create the range of allowed tolerances for the head in the template. All measurements are taken from the top edge of the image.
 - ❖ **Max top of head:** The maximum distance (or height) from the top edge of the template to the top of the subject's head (e.g. .25").
 - ❖ **Min top of head:** The minimum distance (or height) from the top edge of the template to the top of the subject's head (i.e. .5").
 - ❖ **Min bottom of chin:** The minimum distance from the top of the template to the bottom edge of the chin (i.e. 1.5").
 - ❖ **Max bottom of chin:** The maximum distance from the top edge of the template to the bottom edge of the chin (i.e. 1.75").
7. Press the **SAVE** button to save your new template.

NOTE:

You can access your custom templates via the products Custom tab.

Printer Queue

You can check the status of the images you have sent to your printer. The **Print Queues** screen displays the images you have sent to your printer via the IDW520 console; this screen logs whether a sent image:

- ◆ Completed (printed)
- ◆ Unsuccessful (did not print)
- ◆ Pending (waiting to be printed)

1. From your console main screen, press the **PRINT QUEUE** button.

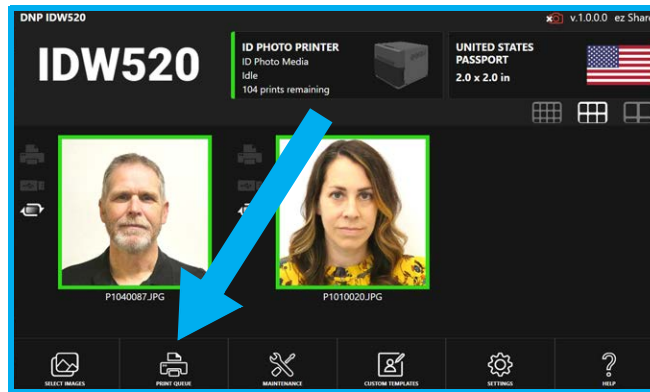

2. The **Printer Queues** screen is displayed. From this screen, you can view the various states of your image by pressing one of the following tabs: **Completed**; **Pending**; **Unsuccessful**.

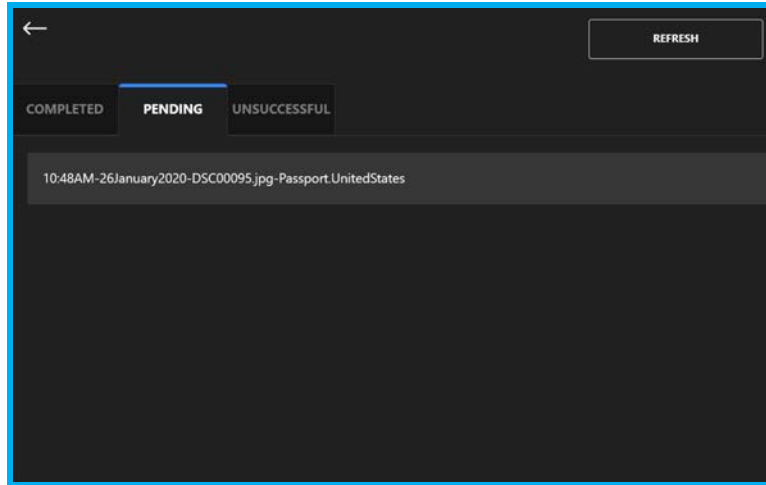

3. Return to the IDW520 main screen by pressing the **return arrow (top left corner)**.

About your ID Photo Printer

In this Chapter

Getting to know your Printer	85
Setting up the Printer	86
Replacing the Printer Paper	86
Replacing the Printer Ribbon	88

Getting to know your Printer

Ultra Compact and Lightweight. Weighing in at less than 13 lbs, it is now easier for anyone to carry this printer from event-to-event. Its small size allows you to carry it in standard shoulder bags.

Innovative Print Sizes. The QW410 4.5" print head and superior electronics and mechanisms allow for many print sizes for more fun and enjoyment for your customers. The QHD 4.5x8" Pano Print media allows for a unique print size, without the need for cropping for 16:9 high definition aspect ratio shots, for example. It can also print many other sizes and aspect ratios to give you options that can make your event unique and fun... like 2"x4", 3"x4", 4"x4", 4"x4.5", among others.

Supports External Battery. This printer has big energy savings... it uses 35% less energy and allows for battery-powered operation that can operate an entire event!

Wireless Ready. With DNP supplied wireless options, the ID Photo printer is compatible with the mobile and wireless world, supporting macOS, iOS, and most other Wi-Fi operating environments.

DNP Quality. The QW410 may be small, but it delivers big on DNP photo quality color prints, the quality you have come to expect from DNP.



Setting up the Printer

The console has on-board help videos that show how to load the print media, i.e., paper and ribbon. The how to videos for this and other operations can also be found on the DNP website.

Replacing the Printer Paper

1. **Remove the old paper (if necessary).** Remove the paper spools from the paper compartment. Remove the old paper from the spools and throw it away.
2. **Prep the new paper roll.** Open the printer media box and remove a roll of paper. Remove the plastic but do not remove the edge seal at this time. Check that the paper edges are flat and are not protruding from the center of the roll. Place the new paper roll on the paper spools. Be sure to press the spools against the paper roll to set the paper tightly against the spools. Also make sure that the paper spacers are removed before placing the roll on the spools.

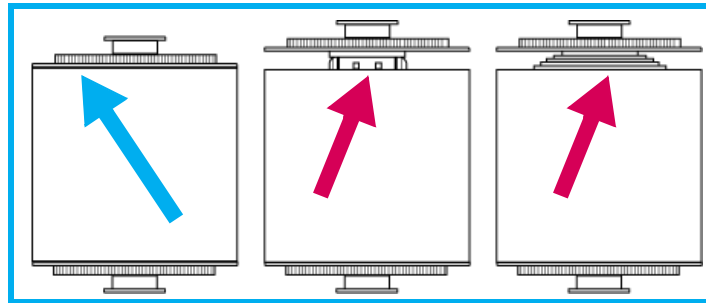

3. **Orient the paper roll.** Make sure the paper roll is oriented so that the leading edge of the paper is coming over the top of the paper roll and directed towards the bottom of the paper roll.
4. **Set the new paper roll in the printer.** Place the spool and new paper roll in the printer paper compartment. Remove the seal on the paper. Advance the paper so that the paper from the top to the bottom of the roll and into the printer paper compartment. Continue feeding the paper until the printer beeps. The ERROR LED changes from flashing red and orange to flashing red.
5. **Replace the scrap bin.** Reset the scrap bin in the printer.

NOTE:

The POWER LED light turns green when the ribbon, paper, and scrap bin are properly installed. If the ERROR LED flashes red, make sure ribbon, paper, and scrap bin are properly seated.

6. **Replace the paper tray.** The paper tray can hold up to 20 prints. However, it is recommended that prints are removed from the tray at regular intervals to prevent jams.



Replacing the Printer Ribbon

1. Press the button on the top of the printer to open the ribbon compartment.
2. If an existing ribbon is in place, remove the ribbon and discard it.
3. Orient the new ribbon so that the supply side (larger side) is towards you and the take-up side (smaller side) is towards the back of the printer.



4. Align the left sides of the ribbon with the grooves and then lower the right sides of the ribbons until they click into place.



5. Remove any slack from the ribbon by rotating the ribbon towards the supply side.
6. Close the ribbon compartment.

Administrative Actions

The IDW520 system software has two administrative sections: the Maintenance section and the Settings section. Use the following information to access and use each section as needed.

In this Chapter

About Administrative Actions	91	Important Information:	
Behaviors Section	93	Using Multiple Systems in Close Proximity	104
Imaging Section	95	Setting the ez Share SSID Number	105
Print Section	96	Repairing the ez Share SD Card	116
ICAO Compliance Certification	96	Toshiba FlashAir Card Procedures	119
ID Types	97	Setting the FlashAir SSID Number	119
System Section	97	Repairing the FlashAir SD Card	121
About the Maintenance Screen	98	Install Local Updates	122
Maintenance Screen Information	99	Quick Support	124
Admin Mode	100	Clear Images Queue	125
Changing the Admin Password	101	Resending Images from the Camera	126
Using LaunchPad	102	Restart Device	127
SD Card Utility	103	Shutdown Device	128
ez Share SD Card Procedures	104		

About Administrative Actions

Your IDW520 console arrives pre-configured to the settings you will need for daily operation. However, if you need to change any of the configuration settings, use this section to do so.

ATTENTION:
DNP Imagingcomm America Corporation recommends not changing the system from the default settings unless you have spoken with technical support. Doing so can cause inconsistencies and vary the output from the recommended tolerance thresholds.

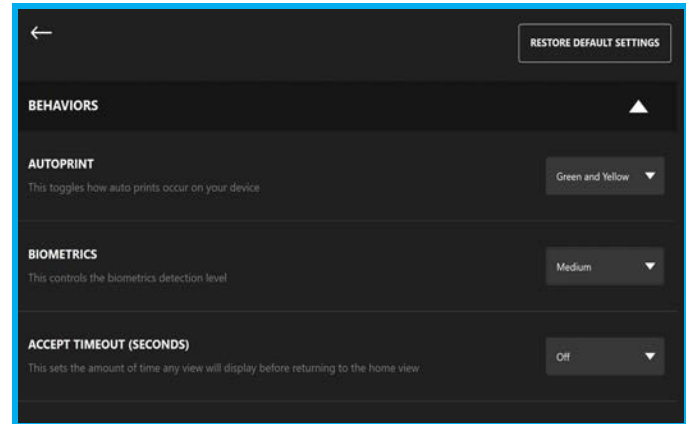

1. To access the settings screen, press the **SETTINGS** button on the bottom of your IDW520 console.

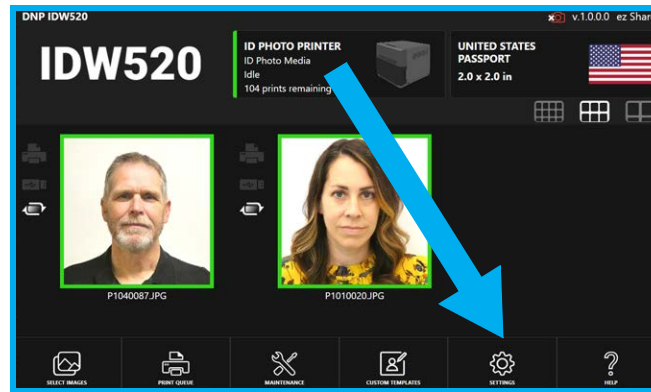

2. The **IDW520 Configuration** screen is displayed. The **IDW520 Configuration** screen is broken up into the following sections: **Behaviors**, **Imaging**, **Print**, and **System**.

Behaviors Section

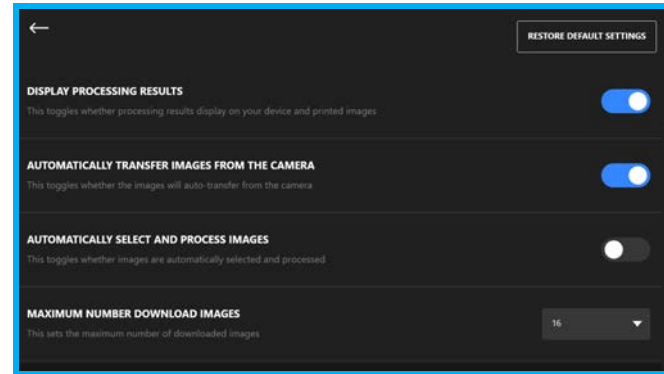
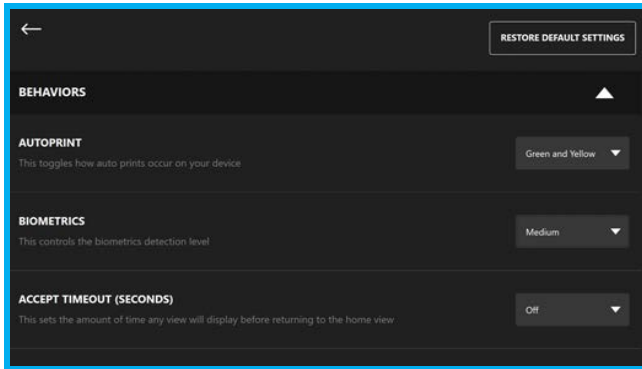

The **System Behaviors** section controls the way the system works to streamline some aspects of the photo printing process. You can configure the following items:

- ❖ **AUTOPRINT:** Automatically prints images that are boxed in green or yellow.
 - ◆ **OFF** - No images are automatically printed.
 - ◆ **GREEN ONLY** - Only Green images are auto-printed.
 - ◆ **GREEN AND YELLOW:** Green and Yellow images are auto-printed.

- ❖ **BIOMETRCIS:** Controls the biometrics detection level.
- ❖ **ACCEPT TIMEOUT (SECONDS):** The amount of time in seconds before you are returned to the main screen.
- ❖ **PRINT COPIES QUANTITY:** Allows you to set how many copies of the image can be printed.
- ❖ **IMAGE DELETION:** The system automatically deletes the **Image Gallery** photos overnight.
- ❖ **DISPLAY PROCESSING RESULTS:** If this option is set to **ON** (by default), the system will display the processing results on the image results screen and on the final print.
- ❖ **AUTOMATICALLY TRANSFER IMAGES FROM CAMERA:** When turned ON, images will be auto-transferred from the camera. *This function is not supported on all older systems.*
- ❖ **AUTOMATICALLY SELECT AND PROCESS IMAGES:** When turned ON, images will be automatically selected and processed.
- ❖ **MAXIMUM NUMBER DOWNLOAD IMAGES:** This sets the maximum number of downloaded images. The maximum number is 16.

Imaging Section

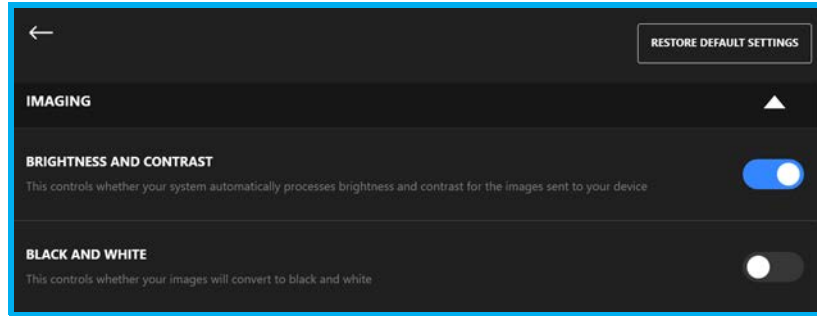

The **Imaging** section settings will tune the way the system first processes the incoming images from the camera. You can configure the following items:

- ❖ **BRIGHTNESS AND CONTRAST:** If set to **ON**, automatically adjusts the image's brightness and contrast to provide the best results possible.
- ❖ **BLACK AND WHITE MODE:** When enabled (default is **OFF**) this setting will change the initial viewing mode of all the images to **Black and White**. The images can be switched back to **Color** by touching the **B&W** icon beside the image on the **Home** screen. A **B&W** button is also available on the image **Edit** screen.

Print Section

Under the **Print** section of this page, you can configure the following items:

- ❖ **CROP MARKS:** Enables/disables crop marks on the final print. Crop marks are helpful when cutting out the images manually with scissors.
- ❖ **FILENAME ON PRINT:** Enables/disables displaying the image file name assigned by the camera on the final print.
- ❖ **RECEIPT/CERT PAGE:** Enables/disables printing a receipt.
- ❖ **TEST PRINT:** Enables/disables printing the Compliance Certification page/receipt for International Civil Aviation Organization (ICAO.)
- ❖ **BARCODE TYPE:** Allows for a barcode to be displayed on the final print.
- ❖ **MEDIA LOW THRESHOLD:** Sets the warning signal for low media. Select a number from the drop-down list for when you want your system to display a low media message.

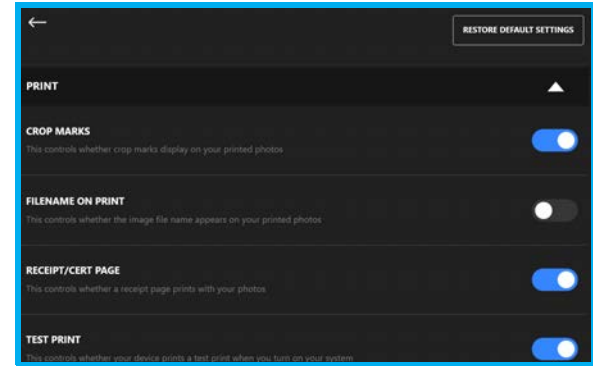

ICAO Compliance Certification

The IDW520 system can print out an ICAO Compliance Receipt Page in addition to the desired ID photo image. This option can be enabled on the **IDW520 Settings** screen. The Certification Page contains the image processing test results of the images sent to the printer, the country template selection used for the image, and the date.

ID Types

The ID template groups in IDW520 the **ID Types** can be turned on or off as needed. The following categories are offered:

- ❖ Visa
- ❖ Resident
- ❖ Citizenship
- ❖ State
- ❖ General
- ❖ Custom

System Section

Under the **System** section of this page, you can configure the following items:

- ❖ **SOUND:** Enables/disables sound.
- ❖ **LANGUAGE:** Select the language to be displayed on your console.
- ❖ **BRIGHTNESS:** Allows you to adjust the brightness of the console display.
- ❖ **SET DATE:** Sets the date.
- ❖ **SET TIME:** Sets the system time.
- ❖ **SCALE AND LAYOUT:** This sets the scaling size of the device display.

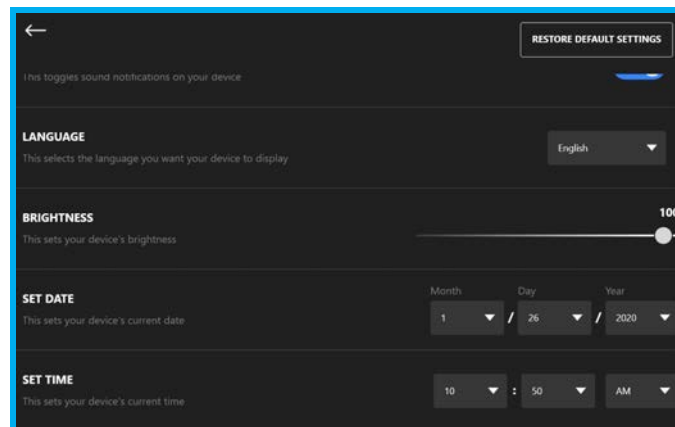

About the Maintenance Screen

Use this screen to access, view, and perform common maintenance tasks.

Printer Information



Printer Status



The screenshot displays the printer maintenance screen for a QW410 printer. The screen is divided into two main sections: printer information and printer status. The printer information section lists various details such as name, status, media left, media type, paper type, life count, firmware version, serial number, and color data version. The printer status section shows storage usage for device, memory, and camera, each with a progress bar and free space information. On the right side of the screen, there are several buttons for administrative tasks: ADMIN MODE, SD CARD UTILITY, QUICK SUPPORT, CLEAR IMAGE QUEUE, RESTART DEVICE, and SHUT DOWN DEVICE.

NAME	QW410
STATUS	Printing
MEDIA LEFT	96
MEDIA TYPE	SD
PAPER TYPE	ID Photo Media
LIFE COUNT	152
FIRMWARE VERSION	QW410 01.06
SERIAL NUMBER	QW4C9C000035
COLOR DATA VERSION	QW410_SD_300_0100.CWD
DEVICE STORAGE - 28.16 GB	9.05 GB Free
MEMORY - 1.93 GB	0.76 GB Free
CAMERA STORAGE - 14.89 GB	14.63 GB Free

ADMIN MODE

SD CARD UTILITY

QUICK SUPPORT

CLEAR IMAGE QUEUE

RESTART DEVICE

SHUT DOWN DEVICE

NOTE:

The camera storage info will be displayed when the camera is turned ON and LINKED via WiFi to the IDW console. *When equipped with the Flash Air SD card only.*

Maintenance Screen Information

The following information tells you about your system and can be used to troubleshoot issues as needed.

- ❖ **Name:** Lists the printer type
- ❖ **Status:** States the printer status
- ❖ **Media Left:** Lists the amount of prints left before the system runs out of paper
- ❖ **Media Type:** The type of printer media that is loaded
- ❖ **Paper Type:** Lists the paper type loaded
- ❖ **Life Count:** The amount of prints the printer has made over its lifetime
- ❖ **Firmware Version:** Currently loaded firmware version
- ❖ **Serial Number:** Serial number for the printer
- ❖ **Color Data Version:** ICC profile information
- ❖ **Device Storage:** How much storage space is used/left on the device
- ❖ **Memory:** How much memory is used/left on the camera *when equipped with a Flash Air SD card only*

Admin Mode

ATTENTION:

Using the Admin Mode - these actions should only be accessed with the guidance of DNP technical support.

Once you've entered the admin password, you can access the Launchpad program that controls access to the system desktop.

1. Press the **Maintenance** icon to open the maintenance screen.
2. Select **Admin Mode**. Enter the passcode.
3. When the options appear, you can either:
 - ❖ **Change Admin Password**: Allows operator to protect the function from being accessed by others.
 - ❖ **Go to Desktop**: Opens Launchpad.

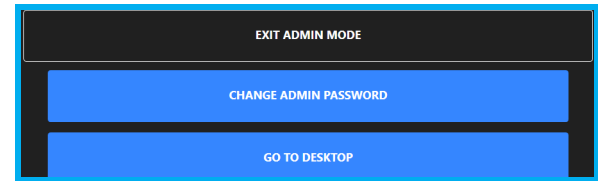

Changing the Admin Password

The Admin password can be changed to another password by the system owner. The new password should be kept safe and secret to avoid any unauthorized changes from occurring.

To change the Admin password:

1. Access the **Maintenance** menu. Then tap the **Admin** button.
2. Enter the **Admin Mode** password.
3. Tap the **CHANGE ADMIN PASSWORD** button.
4. Enter a new numeric password, and then press the **ACCEPT** button.

NOTE:

the new Admin password can be reset back to a default password when needed, e.g. the password has been forgotten or changed unexpectedly.

Contact DNP Technical Support for assistance.

Using LaunchPad

LaunchPad controls access to your underlying system desktop. This keeps your IDW520 console safe from unauthorized access.

NOTE:

If you see the LaunchPad app on your screen, that means that you have touched the **Go to Desktop** button in Maintenance mode or the IDW520 software isn't running. Either restart the IDW520 application from LaunchPad or restart the console.

1. Press the **Maintenance** icon to open the maintenance screen.
2. Select **Admin Mode**.
3. Select **Go to Desktop** to open Launchpad.
4. From the LaunchPad screen, you can:
 - ❖ Restart the applications.
 - ❖ Restart the computer
 - ❖ Shutdown the computer
 - ❖ Access a advanced actions such as the system desktop and other administrative functions.

ATTENTION:

Before accessing advanced actions, it is a good idea to speak with Technical Support for further direction.

SD Card Utility

The SD Recovery Utility can be used to correct problems with your SD Wi-Fi card or to setup replacement card for the IDW520 system. The utility has two main functions – to *SET* the SSID to match or pair your SD Wi-Fi card your IDW520 console and to *REPAIR* or clean and reload the SD Wi-Fi card with the necessary files for use with the IDW520 system. There are two possible SD cards that can be shipped with your system. Be sure to use the procedure for the correct card below.

SPECIAL OPERATOR'S NOTE:

When a location plans to have more than one IDW520 in operation in close proximity to one another, one of the IDW520s **MUST** change the SSID to a different SSID to operate independently. For example, one IDW520 SSID can be named EZSHARE; the 2nd IDW520 SSID should be changed to EZSHARE2. Be sure to change to change both the console SSID and WiFi card SSID so they are paired for operation. Restart the IDW520 after making the changes.

ADDITIONAL NOTE:

IDW systems with Flash Air cards are factory configured to have different SSID in each console.

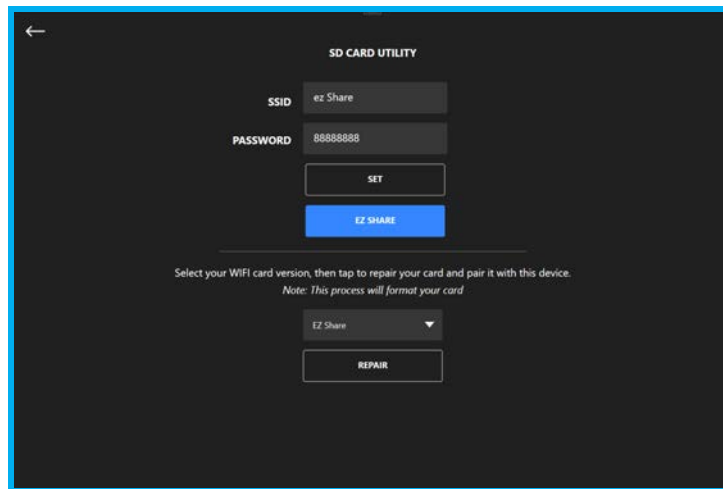

ez Share SD Card Procedures

Use the following procedures for the ez Share SD card - your card may vary slightly from the one pictured, but you must use this section for all ez Share cards. The ez Share card has a switch on the bottom that should remain in the same position.

Important Information: Using Multiple Systems in Close Proximity

IDW520 systems configured with the ez Share Wi-Fi card use a common hidden Wi-Fi SSID of **ezShare**.

When more than one IDW520 is in a room, the nearby systems must be configured with different SSID names.

Use the following procedure to reconfigure the systems with a unique SSID name for each device that are in close proximity to each other (example: ezShare1, ezShare2, etc.).



Setting the ez Share SSID Number

The IDW520 SD Wi-Fi card must be paired to the IDW520 console. If you have received a replacement card or are instructed to reset the SSID on your existing card by a support technician, use the following procedure to do so. Setting or resetting a card allows you to change the network label of the card to coincide with the IDW520 console. The IDW520 SSID name can be found on the main display in the upper right corner of the LCD and on the POST printout. The name must match exactly.

NOTE:

You must change the SSID name in two places - the SD card utility page, and the ez Share configuration change page. The SSID must match in both places in order for the SD card to pair to the console.

A USB keyboard (not supplied) is required for this procedure.

1. Leave the ez Share card in the camera.
2. Power ON the camera and wait for the console to detect the camera.
3. Connect a USB keyboard to the console.

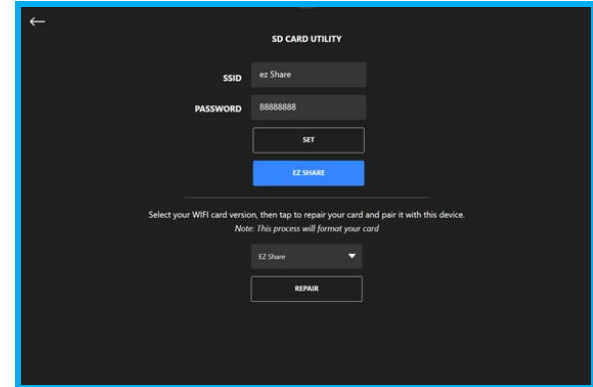

4. Press the **Maintenance** icon to open the maintenance screen.

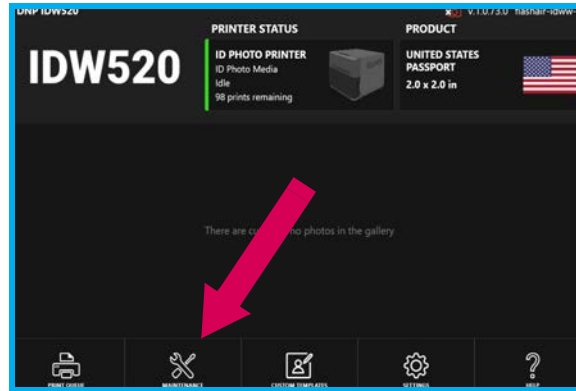

5. Select **SD Card Utility**.

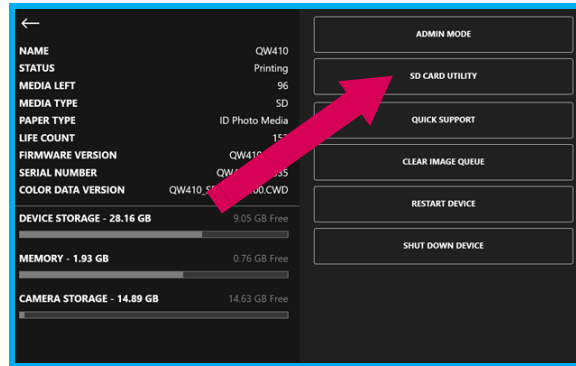

6. Press the blue **ez SHARE** button.

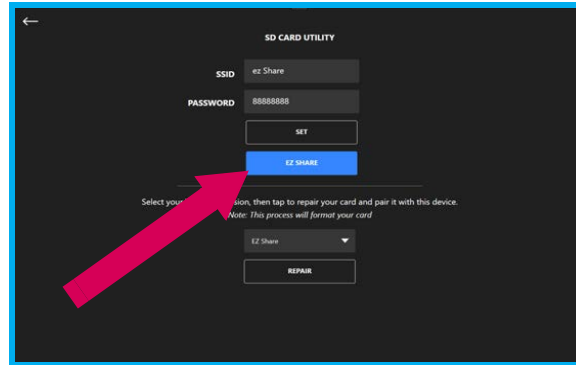

NOTE: The camera must be Power -On when accessing the ez-Share card settings. The wireless connection is used.

7. When the ez Share login screen appears, use the USB keyboard to type **admin** into the administrator password field and press **Confirm**.

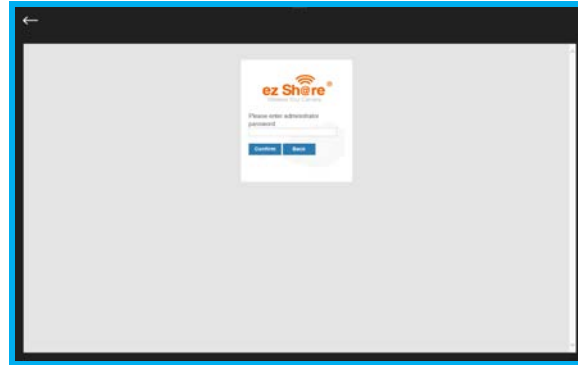

- When the change configuration screen appears, change the WIFI SSID value and WIFI Password. Press **Confirm** to save your changes.

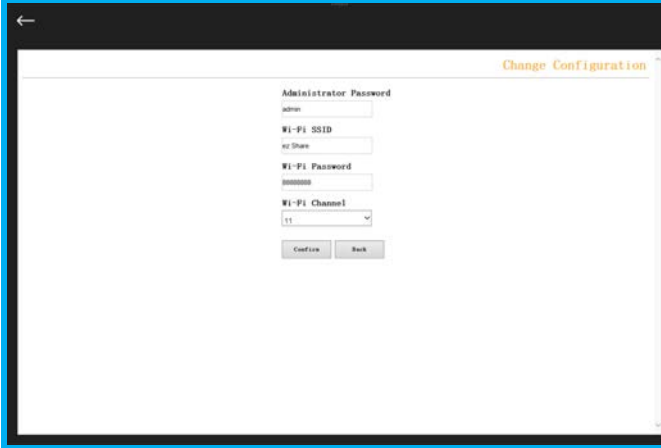

The screenshot displays a mobile application interface titled "Change Configuration". At the top left is a back arrow icon. The title "Change Configuration" is in orange text at the top right. Below the title, there are four input fields: "Administrator Password" (with "admin" entered), "Wi-Fi SSID" (with "ez Share" entered), "Wi-Fi Password" (with "000000" entered), and "Wi-Fi Channel" (with "11" selected in a dropdown menu). At the bottom are two buttons: "Confirm" and "Back".

ATTENTION:

This Change Configuration screen is used to change the settings on the ez Share SD card. When changing the card SSID, the same change must be made on the IDW520 SD Card Utility page to pair the devices.

The new Wi-Fi SSID must be one word with no spaces.

NOTE on Multiple IDW520 Systems

When more than one IDW520 system configured EZ-Share WiFi cards are operating in the same location or in close proximity to one other, the SSID of one of the units **MUST** be changed to a different SSID. As an example, the SSID of the 2nd unit could be set to EZSHARE2.

Be sure to set both IDW console and the EZ-Share card to the new SSID in order to pair them and allow the system to operate properly.

9. Click **OK** when the pop-up message appears.

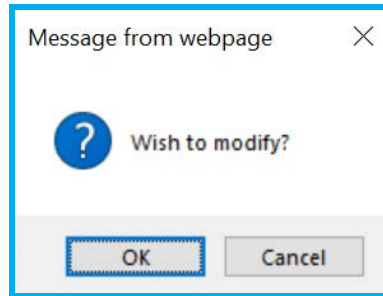

10. After about ten seconds, click **OK** when the configuration success pop-up appears.

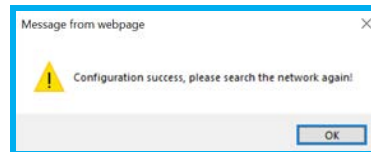

11. Click the **back arrow** at the top left corner of the screen to return to the SD Card Utility page.

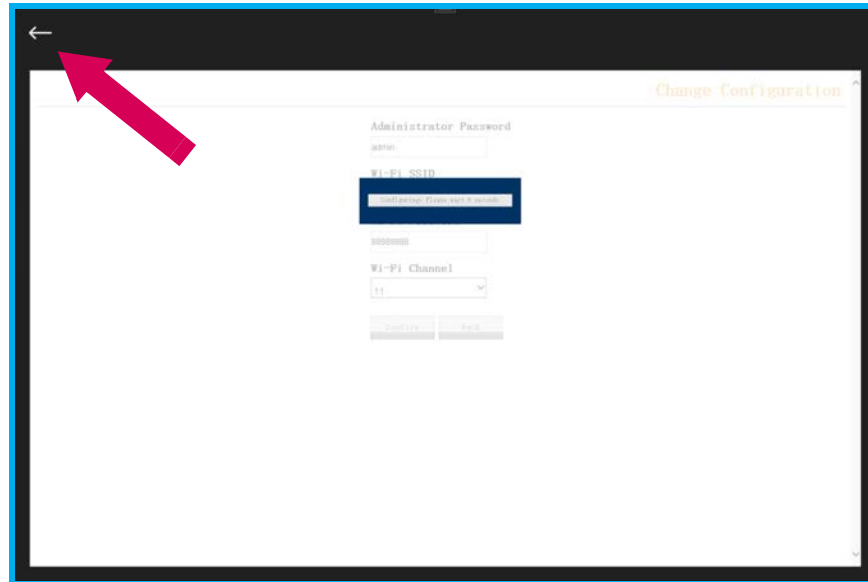

- On the SD Card Utility page, touch the **SSID** field text area. Use the on-screen keyboard to enter the Wi-Fi SSID you entered on the ez Share configuration page. The SSID must match exactly, character for character; it is case sensitive.

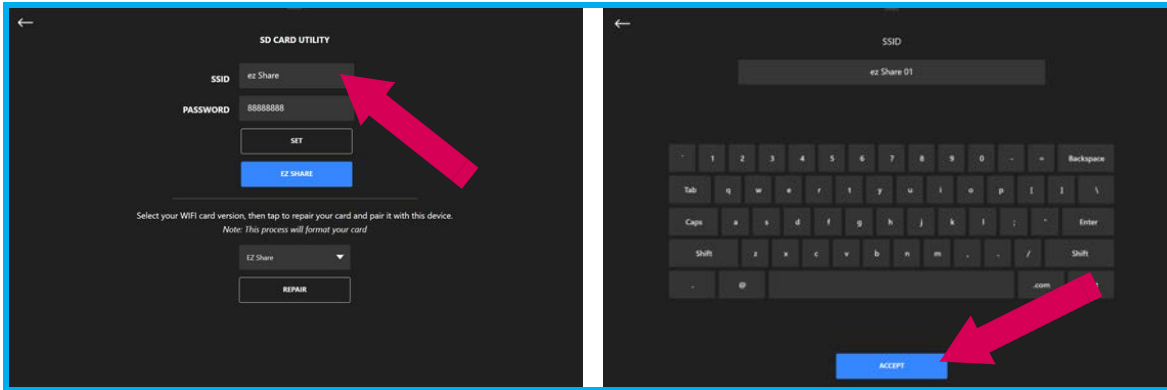

13. Touch the **Password** field text area. Use the on-screen keyboard to enter the Wi-Fi password you entered on the ez Share configuration page

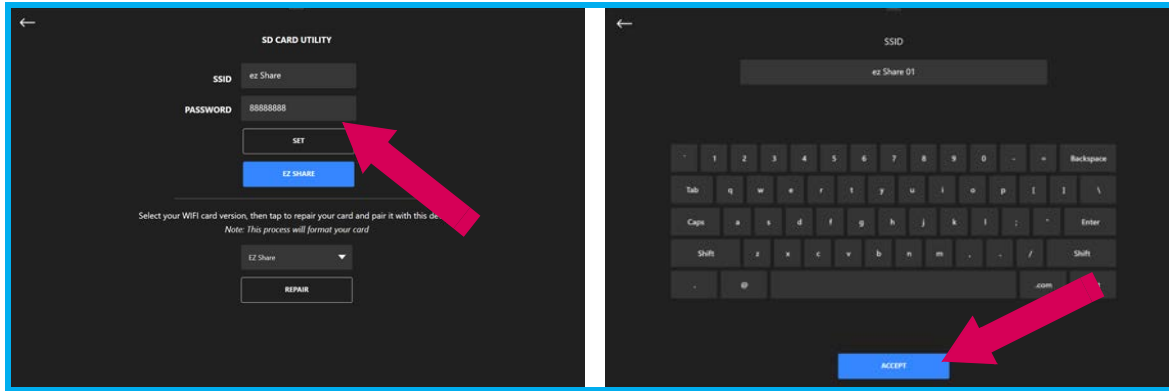

14. Making sure to have the SD card in the camera, and the camera powered ON, click the **Set** button. The console will attempt to reconnect with the ez Share card

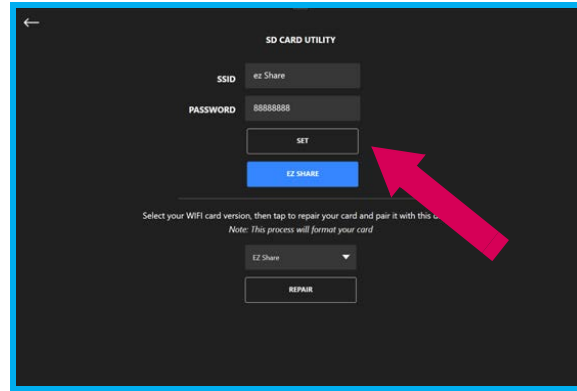

15. If successful, you will see the text appear: *The WIFI card is now connected!*

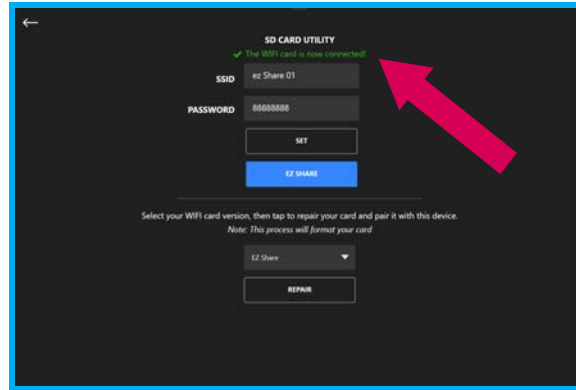

16. Return to the console home screen and the camera icon should be green with the SSID value displayed.

17. Your card's SSID number is now set to work with your IDW520 system.

Repairing the ez Share SD Card

You can repair, or reformat, your SD card if the data has been corrupted or you've added a new card to your inventory. If you use the repair option, any data that is stored on the card will be erased.

1. Remove the ez Share card from the camera. Insert the ez Share card into the USB SD Card Adapter.
2. Insert the SD Card Adapter into one of the USB ports on the PIPO device.

3. Press the **Maintenance** icon to open the maintenance screen.
4. Select **SD Card Utility**.

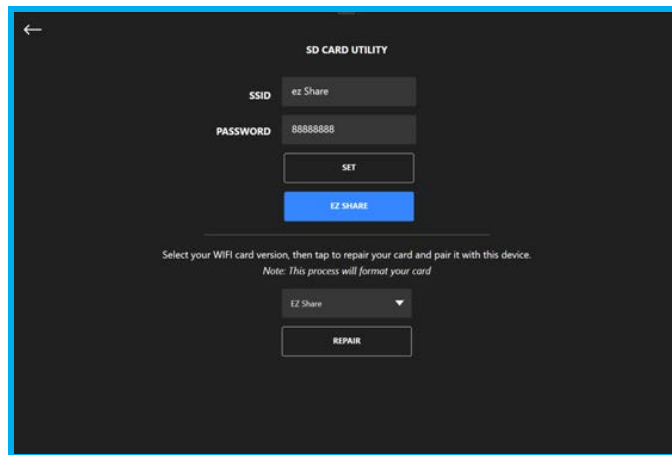

5. Click the **Repair** button. Then after the repair is complete, you will see the message “*Wi-Fi card successfully repaired.*”

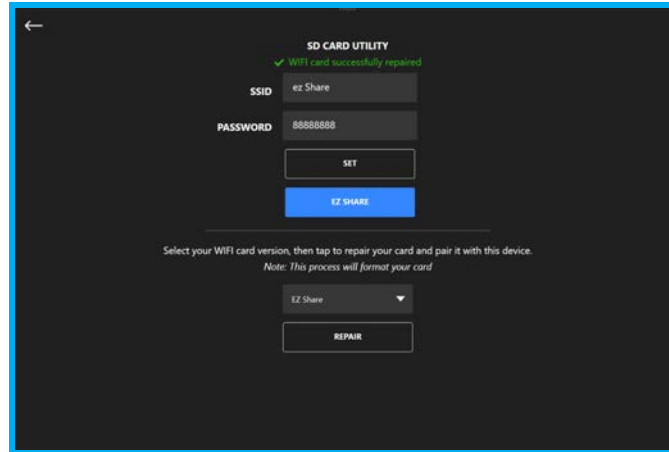

6. Remove the USB SD Card Adapter from the console, and the card from the adapter.
7. Insert the ez Share card back into your camera.
8. Restart the IDW520 console.
9. Power ON the camera.
10. You should see the green camera icon and text "ez Share" in the top right corner of the screen.

Toshiba FlashAir Card Procedures

Use this section for the Toshiba FlashAir card.

Setting the FlashAir SSID Number

The IDW520 SD Wi-Fi card must be paired to the IDW520 console. If you have received a replacement FlashAir card or are instructed to reset the SSID on your existing card by a support technician, use the following procedure to do so.

Setting or resetting a card allows you to change the network label of the card to coincide with the IDW520 console. The IDW520 SSID name can be found on the main display in the upper right corner of the LCD and on the POST printout. The name must match exactly.



When renaming the SSID, you must first set the card, then set the console SSID to match.

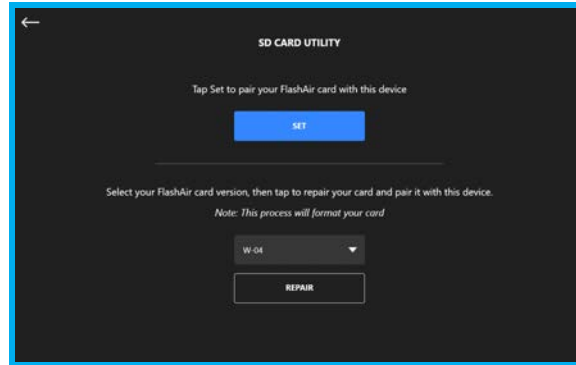

1. Insert the card into the SD card adapter and into the console.
2. Press the **Maintenance** icon to open the maintenance screen.
3. Select **SD Recovery Utility**.
4. Press the **Set** button.
5. Your card's SSID number is now set to work with your IDW520 system.
6. If setting the SSID number doesn't work unplug the SD card adapter, replug it, and try the procedure again.

Repairing the FlashAir SD Card

You can repair, or reformat, your SD card if the data has been corrupted or you've added a new card to your system. If you use the repair option, any data that is stored on the card will be erased.

1. Press the **Maintenance** icon to open the maintenance screen.
2. Select **SD Recovery Utility**.
3. Select the SD card **W-0X version** from the drop-down list. The W-0X version is usually stated on the front of the card.
4. Press the **Repair** button.
5. If repairing the card doesn't work, unplug the SD card adapter, replug it, and try the procedure again.



Install Local Updates

The IDW520 can be updated using USB flash device and downloading the IDW update from the DNP website. Certain improvements and changes will be added to the system operation

NOTE

Updates cannot be un-installed.

1. Press the **Maintenance** icon to open the maintenance screen.
2. Tap the **Clear Image Queue** button to empty the image gallery before proceeding and ensure the Camera is turned off throughout the process.
3. Tap **Admin Mode** and enter the admin password to access the local update button.

NOTE

Skip this step if your version shows the **Install Local Updates** button on the main level.

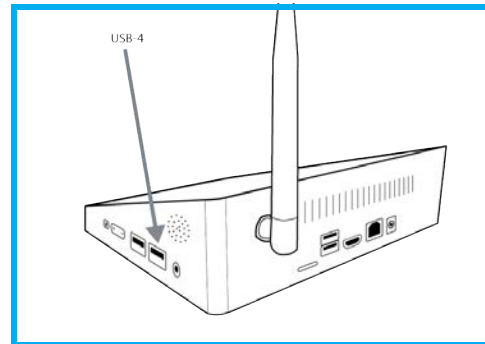

4. Insert the USB drive with the update file into the **USB-4 port** on the side of the console.
5. Tap the **Install Local Updates** icon.
6. Follow any on-screen prompts to complete the update.

IMPORTANT NOTES ON PERFORMING THE IDW520 UPDATES

Please read the update Install Instructions carefully and follow all the steps including any and all preparation steps. Failure to follow the steps or perform the preparation may result in a failed update.

Always empty the image gallery of the IDW using the **Clear Image Queue** button in the maintenance menu prior to performing the update.

Use of a USB v3.0 flash drive is recommended.

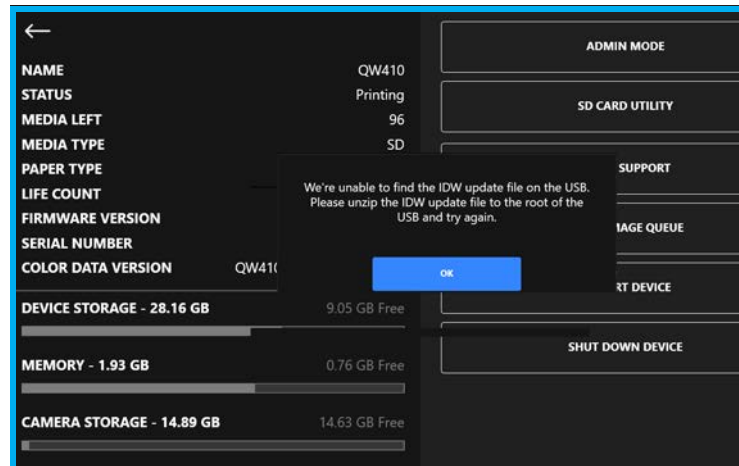

When the IDW update software is delivered in a ZIP file, the ZIP file must be decompressed on your PC prior to loading the update onto the USB drive. The IDW update file must be copied to the root folder of the USB flash drive for the IDW update button to find it. If the ZIP file is not decompressed and not copied to the root file of the USB flash drive, you will receive the following error message.

Quick Support

The IDW processor console has the ability to be accessed remotely by DNP Tech Support. This function is useful to diagnose and resolve certain issues. Use this option only when instructed to do so by a Technical Support Agent. A scheduled appointment is necessary.

NOTE:

The IDW console must be connected to the Internet for this function to operate.

1. Press the **Maintenance** icon to open the maintenance screen.
2. Tap **Admin Mode** and enter the admin password.
3. Select the **Quick Support** button. It can take up to thirty (30) seconds for the software to connect.
4. Follow any prompts or instructions that are given to you by the technical support agent to complete the sign on process.

Clear Images Queue

You can remove the images that are displayed in the image gallery of your console. This will also erase the image files on the IDW console.

NOTE: It will not erase images from the SD camera card. When operating in **Auto-Transfer** mode, the images on the camera card will transfer to the console again until they are erased from the camera card too.

1. From the dashboard, press the **MAINTENANCE** icon at the bottom of the screen.
2. Tap the **CLEAR IMAGE QUEUE** button.
3. You're asked if your sure you want to delete the images. Press **YES** to continue or **NO** to cancel.
4. Any images that were on your console have now been removed from the image gallery.
5. Press the **return arrow** (top right corner) to return to the IDW520 home screen.
6. Tap the image and press the **Delete** button.

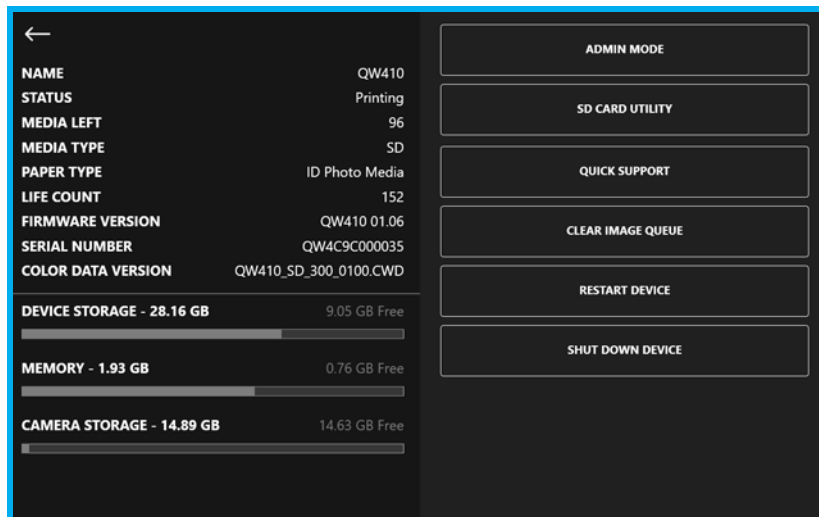

Resending Images from the Camera

1. When the system is configured for **Auto-Transfer** mode, the system will transfer the most recent images. Delete the image from the camera card that are not wanted to see the other images.
2. When the IDW is configured for DPOF transfer mode and the images are removed from the **Image Gallery**, they can be resent from the camera as needed.

Housekeeping Tip: Always delete the old image from the camera card daily.

When the IDW is configured for DPOF transfer mode and the images are removed from the Image Gallery they can be resent from the camera as needed.

NOTE: The **Image Gallery** will automatically be cleared overnight when the IDW520 system is left running. It will not delete images from the camera SD card. Delete the SD card images on the camera.

Restart Device

You can remove the images that are displayed in the image gallery of your console.

3. From the dashboard, press the **MAINTENANCE** icon at the bottom of the screen.
4. Tap the **RESTART DEVICE** button.
5. You're asked if your sure you want to restart the device. Press **YES** to continue or **NO** to cancel.

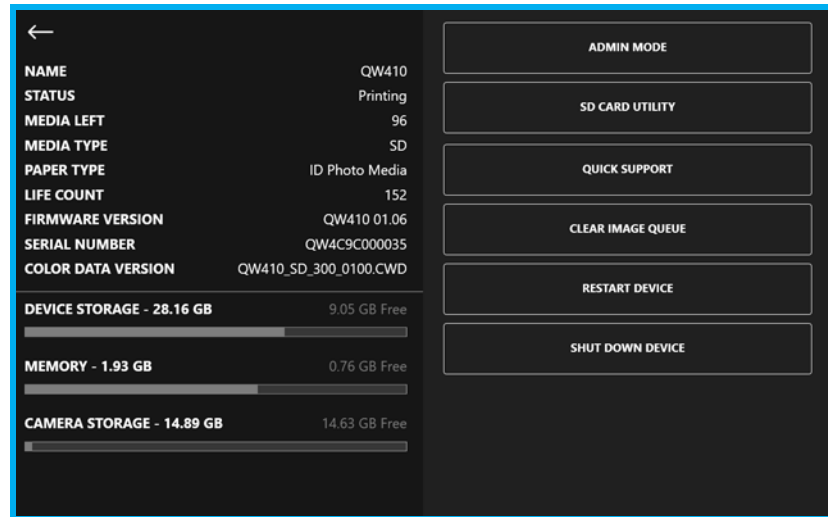

Shutdown Device

1. From the dashboard, press the **MAINTENANCE** icon at the bottom of the screen.
2. Tap the **SHUTDOWN DEVICE** button.
3. You're asked if you're sure you want to restart the device. Press **YES** to continue or **NO** to cancel.

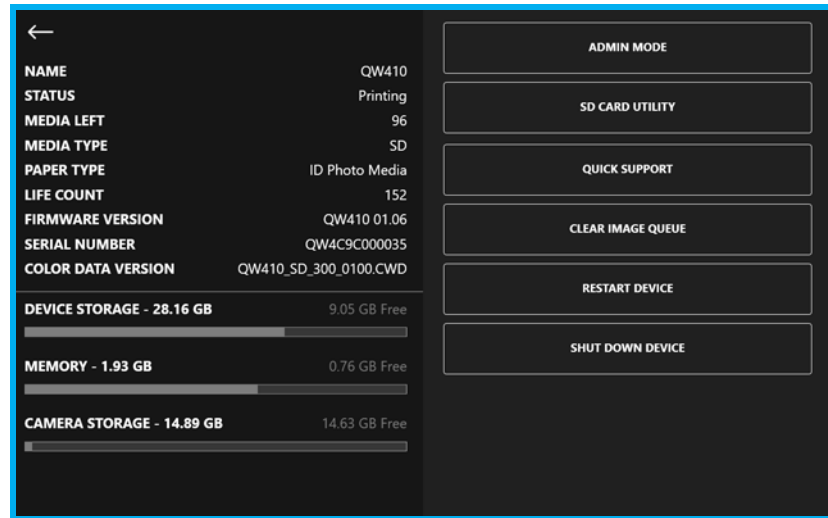

Troubleshooting

In this Chapter

General Troubleshooting Steps 130

General Troubleshooting Steps

If you experience any issues with your system use the steps below to troubleshoot the issue. To find out the version of software running on your system, look in the upper right corner of the dashboard.

1. Did the IDW520 print a test page when you powered ON the system?
 - ❖ **YES:** Continue with step 3.
 - ❖ **NO:** Check the printer ready state. Only the **Green Light** should be **ON**. If the printer has only green lights, continue with step 3. If the printer state is anything besides idle (green lights), check the printer for error conditions and check that the media is properly loaded. Continue with step 2.
2. Power cycle the IDW520 console and ID printer.
 - ❖ On the rear of the printer, toggle the power switch to OFF for a few seconds, and then toggle it back to ON. Wait for the printer to be ready single Green light is on at the front of the printer.) On the IDW520 console, touch the **GEAR** icon. From the menu, press the **SHUTDOWN IDW520** button. Only as a last resort, if the shutdown option does not work, press the POWER button on the right side of the unit, and when the menu appears, select **Reboot** from the menu. A test print should print after the unit completes the restart.
3. Check the IDW520 printer status icon. If the printer is shown to be in a ready state, continue below. If the printer isn't in a ready state, check for and clear any issues then power cycle the printer and the console to continue.
4. Verify that the camera has at least half battery power available.
5. If the camera has less than half of the battery power remaining, recharge the camera batteries.
6. Make sure you are standing within 10 feet of the IDW520 console when transferring the image. Closer is better.
7. If you are in an environment with a large amount of wireless traffic, try standing closer to the unit.

8. Look for the **CAMERA FOUND** message on the console screen. Verify that the camera icon in the top right corner is green.
9. If there is no message, power cycle the camera and wait to see if the system discovers it.
10. **Poor Image Print Quality.** Lighting the subject properly is very important to good picture taking. While the Camera and IDW processor will auto-adjust image brightness within its limits, having a properly lit subject and background is key to good ID photos. Bright natural light or diffused room lighting will provide the best illumination. Some lighting conditions to avoid:

- ◆ Avoid bright lights directly overhead, the face must be illuminated.
- ◆ Avoid locations with direct sunlight which can cause harsh shadows or improper lighting on the whole face.
- ◆ Avoid lighting from one side or the other.
- ◆ When using the camera flash be sure the subject is close to the background to minimize the harsh shadows.

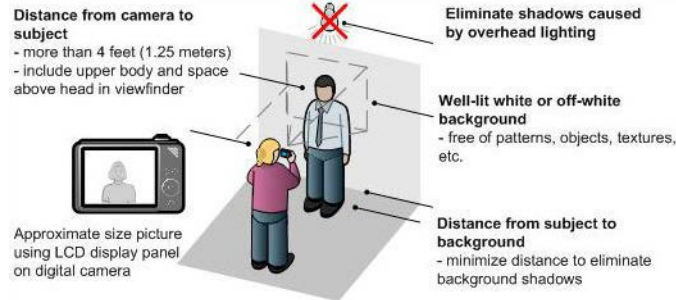
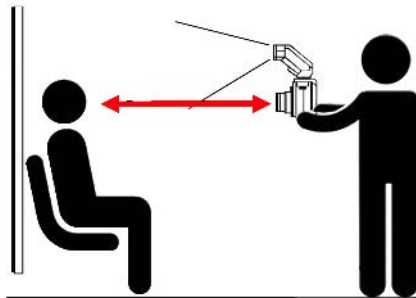

11. If you are still experiencing issues with your system, contact DNP IAM technical support at 855-367-7604.

Acknowledgements

In this Chapter

License Agreements	133
Other Agreements	136

License Agreements

SOFTWARE END USER LICENSE AGREEMENT (EULA). PLEASE READ THE FOLLOWING TERMS AND CONDITIONS CAREFULLY BEFORE USING THIS SOFTWARE. USING THIS SOFTWARE INDICATES YOUR ACCEPTANCE OF THESE TERMS AND CONDITIONS. IF YOU DO NOT AGREE WITH THESE TERMS AND CONDITIONS, DO NOT DOWNLOAD OR USE THIS SOFTWARE. This Software License Agreement (the “Software License Agreement”) is an agreement entered into by and between you (hereinafter referred to as “You” or “Your”) and DNP Imagingcomm America Corporation (DNP IAM) (the “Licensor”) for any and all software and documentation provided by the Licensor (the “Software”). The Software includes items available either by Internet download, contained in a CD/DVD or contained within a 3rd party software installer. By using the Software, You agree to the terms of this Software License Agreement. The Licensor grants You a non-exclusive, non-transferable license to use one copy of the Software in object code only.

OWNERSHIP RETAINED BY LICENSOR. The Licensor owns all title and copyrights in and to the Software and the Licensor has the full right and authority to grant the license granted herein. Your license does not give You any title or ownership in the Software, nor is it a sale of any rights in the Software. The only right granted to You is the right to use the Software in accordance with the terms of this Software License Agreement. All rights not specifically granted to You under this Software License Agreement are reserved by the Licensor. You may make only a single copy of the Software as a backup copy, provided that it includes all notices and markings, including copyright, trademark and other proprietary notices as on the original. Such backup copy of the Software may not be in use at any time unless the original Software is damaged beyond use, and both the original and the copy must remain in Your possession and control. You may not copy the software onto any public

network. You may not, and You may not allow others to modify, disassemble, decompile, translate, reverse engineer, reproduce, make derivative works of or enhance the Software. You may not, and You may not allow others to rent, lease, sell, sub license, export or otherwise transfer the Software to any other person. In addition to any other rights it may have, the Licensor may terminate this Software License Agreement if You fail to comply with the terms and conditions hereof. In such event, You must cease all use of the Software and destroy all copies of the Software and all of its component parts. At the Licensor’s sole discretion, the Licensor may from time to time provide You with updates to the Software. Any such updates shall become part of the Software licensed to You hereunder and subject to all of the terms and conditions of this Software License Agreement.

DISCLAIMER OF WARRANTIES. The Licensor expressly disclaims any and all warranties relative to the Software. THE SOFTWARE IS PROVIDED “AS IS,” WITHOUT WARRANTY OF ANY KIND, EXPRESS OR IMPLIED, INCLUDING, WITHOUT LIMITATION, THE IMPLIED WARRANTIES OF MERCHANTABILITY AND FITNESS FOR A PARTICULAR PURPOSE, NON-INFRINGEMENT, COURSE OF DEALING AND USAGE OF TRADE. YOU HEREBY ASSUME THE ENTIRE RISK AS TO THE QUALITY AND PERFORMANCE OF THE SOFTWARE.

LIMITATION OF LIABILITY. In no event shall the Licensor be liable for any direct, special, incidental, indirect or consequential damages whatsoever to You (including, without limitation, damages for loss of profits, sales or data or for business interruption) arising out of the use of or inability to use the Software, even if the Licensor has been advised of the possibility of such damages. In any event, the Licensor’s entire liability under any provision shall be limited to the amount actually paid

by You for the Software. Because some states and jurisdictions do not allow the exclusion or limitation of liability, the above limitation may not apply to You. If any provision of the Software License Agreement is declared by a court of competent jurisdiction to be invalid for any reason, such invalidity shall not affect the remaining provisions hereof.

GOVERNING LAW. This Software License Agreement shall be governed by the laws of the State of North Carolina without regard to conflict of laws principles. You and the Licensor hereby consent to the exclusive venue and jurisdiction of the state and federal courts located in Mecklenburg County, North Carolina.

TAXES. You are responsible for all taxes or charges imposed by any government or regulatory authority with respect to the delivery and use of the Software, but exclusive of any taxes based upon the Licensor's net income.

TERM. This License Agreement is effective until terminated. You may terminate this License Agreement by ceasing to use the Software and, if applicable, returning the Software to the Licensor. Licensor may terminate this License Agreement if You breach any of the terms and conditions. Upon termination of this License Agreement for any reason, You shall cease using the Software and, if applicable, return the Software to the Licensor. All provisions of this Agreement relating to disclaimers of warranties, limitation of liability, remedies, or damages, and Licensor's proprietary rights shall survive termination.

ACKNOWLEDGMENTS. The ICC profiles provided by DNP Imagingcomm America Corporation are prepared using the technology of X-Rite, Incorporated. YOU ACKNOWLEDGE YOU HAVE READ AND UNDERSTAND THIS AGREEMENT AND AGREE TO BE BOUND BY ITS TERMS. YOU FURTHER AGREE THAT THIS AGREEMENT IS THE COMPLETE AND EXCLUSIVE STATEMENT OF THE AGREEMENT BETWEEN YOU AND LICENSOR, AND SUPERSEDES ANY PROPOSAL OR PRIOR AGREEMENT, ORAL OR WRITTEN, AND

ANY OTHER COMMUNICATIONS RELATING TO THE SOFTWARE ADDRESSED IN THIS AGREEMENT.

The information contained in this document represents the current view of DNP Imagingcomm America Corporation on the issues discussed as of the date of publication. Because DNP Imagingcomm America Corporation must respond to changing market conditions, it should not be interpreted to be a commitment on the part of DNP Imagingcomm America Corporation, and DNP Imagingcomm America Corporation cannot guarantee the accuracy of any information presented after the date of publication. This document is for informational purposes only. DNP Imagingcomm America Corporation MAKES NO WARRANTIES, EXPRESSED OR IMPLIED, AS TO THE INFORMATION IN THIS DOCUMENT.

Complying with all applicable copyright laws is the responsibility of the user. Without limiting the rights under copyright, no part of this document may be reproduced, stored in or introduced into a retrieval system, or transmitted in any form or by any means (electronic, mechanical, photocopying, recording, or otherwise), or for any purpose, without the express written permission of DNP Imagingcomm America Corporation

DNP Imagingcomm America Corporation may have patents, patent applications, trademarks, copyrights, or other intellectual property rights covering subject matter in this document. Except as expressly provided in any written license agreement from DNP Imagingcomm America Corporation, the furnishing of this document does not give any license to these patents, trademarks, copyrights, or other intellectual property.

IDW520™ is a trademark of DNP Imagingcomm America Corporation PrintRush® and Party Print® are registered trademarks of Dai Nippon Printing Company LTD. Apple, the Apple logo, iPad, and iPhone are trademarks of Apple Inc., registered in the U.S. and other countries. App Store is a service mark of Apple Inc. Amazon is a trademark of Amazon.com Inc. or its affiliates. Android and Google Play are

trademarks of Google, Inc. SD, SDHC and SDXC are trademarks or registered trademarks of SD-3C, LLC in the United States, other countries or both. Sony® and Cyber-shot® are the registered trademarks of the Sony Corporation. FlashAir™ is the trademark of Toshiba Corporation. PiPO™ is the trademark of PiPO Corporation. ez Share® is a trademark of LZeal Information Technology Co, Ltd. USPS® is a registered trademark of the United States Postal Service. The names of actual companies and products mentioned herein may be the trademarks of their respective owners.

Image Scaling Utility Class

Copyright (c) 2010, Sony Ericsson Mobile Communication AB. All rights reserved.

Redistribution and use in source and binary forms, with or without modification, are permitted provided that the following conditions are met:

Redistributions of source code must retain the above copyright notice, this list of conditions and the following disclaimer. Redistributions in binary form must reproduce the above copyright notice, this list of conditions and the following disclaimer in the documentation and/or other materials provided with the distribution. Neither the name of the Sony Ericsson Mobile Communication AB nor the names of its contributors may be used to endorse or promote products derived from this software without specific prior written permission.

THIS SOFTWARE IS PROVIDED BY THE COPYRIGHT HOLDERS AND CONTRIBUTORS "AS IS" AND ANY EXPRESS OR IMPLIED WARRANTIES, INCLUDING, BUT NOT LIMITED TO, THE IMPLIED WARRANTIES OF MERCHANTABILITY AND FITNESS FOR A PARTICULAR PURPOSE ARE DISCLAIMED.

IN NO EVENT SHALL THE COPYRIGHT HOLDER OR CONTRIBUTORS BE LIABLE FOR ANY DIRECT, INDIRECT,

INCIDENTAL, SPECIAL, EXEMPLARY, OR CONSEQUENTIAL DAMAGES (INCLUDING, BUT NOT LIMITED TO, PROCUREMENT OF SUBSTITUTE GOODS OR SERVICES; LOSS OF USE, DATA, OR PROFITS; OR BUSINESS INTERRUPTION) HOWEVER CAUSED AND ON ANY THEORY OF LIABILITY, WHETHER IN CONTRACT, STRICT LIABILITY, OR TORT (INCLUDING NEGLIGENCE OR OTHERWISE) ARISING IN ANY WAY OUT OF THE USE OF THIS SOFTWARE, EVEN IF ADVISED OF THE POSSIBILITY OF SUCH DAMAGE.

Boost Software License - Version 1.0 - August 17th, 2003

Permission is hereby granted, free of charge, to any person or organization obtaining a copy of the software and accompanying documentation covered by this license (the "Software") to use, reproduce, display, distribute, execute, and transmit the Software, and to prepare derivative works of the Software, and to permit third-parties to whom the Software is furnished to do so, all subject to the following:

The copyright notices in the Software and this entire statement, including the above license grant, this restriction and the following disclaimer, must be included in all copies of the Software, in whole or in part, and all derivative works of the Software, unless such copies or derivative works are solely in the form of machine-executable object code generated by a source language processor.

THE SOFTWARE IS PROVIDED "AS IS", WITHOUT WARRANTY OF ANY KIND, EXPRESS OR IMPLIED, INCLUDING BUT NOT LIMITED TO THE WARRANTIES OF MERCHANTABILITY, FITNESS FOR A PARTICULAR PURPOSE, TITLE AND NON-INFRINGEMENT. IN NO EVENT SHALL THE COPYRIGHT HOLDERS OR ANYONE DISTRIBUTING THE SOFTWARE BE LIABLE FOR ANY DAMAGES OR OTHER LIABILITY, WHETHER IN CONTRACT, TORT OR OTHERWISE, ARISING FROM, OUT OF OR IN CONNECTION WITH THE SOFTWARE OR THE USE OR OTHER DEALINGS IN THE SOFTWARE.

Other Agreements

This copy of the libpng notices is provided for your convenience. In case of any discrepancy between this copy and the notices in the file png.h that is included in the libpng distribution, the latter shall prevail.

COPYRIGHT NOTICE, DISCLAIMER, and LICENSE:

If you modify libpng you may insert additional notices immediately following this sentence.

This code is released under the libpng license.

libpng versions 1.0.7, July 1, 2000 through 1.6.29, March 16, 2017 are Copyright (c) 2000-2002, 2004, 2006-2017 Glenn Randers-Pehrson, are derived from libpng-1.0.6, and are distributed according to the same disclaimer and license as libpng-1.0.6 with the following individuals added to the list of Contributing Authors:

Simon-Pierre Cadieux

Eric S. Raymond

Mans Rullgard

Cosmin Truta

Gilles Vollant

James Yu

Mandar Sahastrabudde

Google Inc.

Vadim Barkov and with the following additions to the disclaimer:

There is no warranty against interference with your enjoyment of the library or against infringement. There is no warranty that our efforts or the library will fulfill any of your particular purposes or needs. This library

is provided with all faults, and the entire risk of satisfactory quality, performance, accuracy, and effort is with the user.

Some files in the "contrib" directory and some configure-generated files that are distributed with libpng have other copyright owners and are released under other open source licenses.

libpng versions 0.97, January 1998, through 1.0.6, March 20, 2000, are Copyright (c) 1998-2000 Glenn Randers-Pehrson, are derived from libpng-0.96, and are distributed according to the same disclaimer and license as libpng-0.96, with the following individuals added to the list of Contributing Authors:

Tom Lane

Glenn Randers-Pehrson

Willem van Schaik

libpng versions 0.89, June 1996, through 0.96, May 1997, are Copyright (c) 1996-1997 Andreas Dilger, are derived from libpng-0.88, and are distributed according to the same disclaimer and license as libpng-0.88, with the following individuals added to the list of Contributing Authors:

John Bowler

Kevin Bracey

Sam Bushell

Magnus Holmgren

Greg Roelofs

Tom Tanner

Some files in the "scripts" directory have other copyright owners but are released under this license. libpng versions 0.5, May 1995, through 0.88,

January 1996, are Copyright (c) 1995-1996 Guy Eric Schalnat, Group 42, Inc. For the purposes of this copyright and license, “Contributing Authors” is defined as the following set of individuals:

Andreas Dilger

Dave Martindale

Guy Eric Schalnat

Paul Schmidt

Tim Wegner

The PNG Reference Library is supplied “AS IS”. The Contributing Authors and Group 42, Inc. disclaim all warranties, expressed or implied, including, without limitation, the warranties of merchantability and of fitness for any purpose. The Contributing Authors and Group 42, Inc.

assume no liability for direct, indirect, incidental, special, exemplary, or consequential damages, which may result from the use of the PNG Reference Library, even if advised of the possibility of such damage.

Permission is hereby granted to use, copy, modify, and distribute this source code, or portions hereof, for any purpose, without fee, subject to the following restrictions:

1. The origin of this source code must not be misrepresented.
2. Altered versions must be plainly marked as such and must not be misrepresented as being the original source.
3. This Copyright notice may not be removed or altered from any source or altered source distribution.

The Contributing Authors and Group 42, Inc. specifically permit, without fee, and encourage the use of this source code as a component to supporting the PNG file format in commercial products. If you use this source code in a product, acknowledgment is not required but would be appreciated.

END OF COPYRIGHT NOTICE, DISCLAIMER, and LICENSE.

TRADEMARK:

The name “libpng” has not been registered by the Copyright owner as a trademark in any jurisdiction. However, because libpng has been distributed and maintained world-wide, continually since 1995, the Copyright owner claims “common-law trademark protection” in any jurisdiction where common-law trademark is recognized.

OSI CERTIFICATION:

Libpng is OSI Certified Open Source Software. OSI Certified Open Source is a certification mark of the Open Source Initiative. OSI has not addressed the additional disclaimers inserted at version 1.0.7.

EXPORT CONTROL:

The Copyright owner believes that the Export Control Classification Number (ECCN) for libpng is EAR99, which means not subject to export controls or International Traffic in Arms Regulations (ITAR) because it is open source, publicly available software, that does not contain any encryption software. See the EAR, paragraphs 734.3(b)(3) and 734.7(b).

Glenn Randers-Pehrson (glennrp at users.sourceforge.net) March 16, 2017

Importer:

DNP NA

Le Raphael Paris Nord 2 22 Avenue de Nations BP 51077
Villepinte, 95948 ROISSY CH DE GAULLE CEDEX, FRANCE

Manufacturer:

PIPO Technology Co., Ltd.

c/o DNP Imagingcomm America Corporation
4524 Enterprise Drive NW

Concord, NC 28027 United States

If you want to dispose of this product, do not mix with general household waste. There is a separate collection system for used electronics products in accordance with legislation under the WEEE Directive. For details, please consult with your dealer.

PIPO Technology Co., Ltd. hereby declares that this Wireless Print Server is in compliance with the essential requirements and other relevant provisions of Directive 1999/5/EC. For details, please access the URL: <http://www.dnpphoto.eu/en/>

Par la présente PIPO Technology Co., Ltd. déclare que l'appareil est conforme aux exigences essentielles et aux autres dispositions pertinentes de la directive 1999/5/CE. Pour toute information complémentaire, veuillez consulter l'URL suivante: <http://www.dnpphoto.eu/fr/>

Hiermit erklärt PIPO Technology Co., Ltd., dass sich das Gerät Wireless Print Server in Übereinstimmung mit den grundlegenden Anforderungen und den übrigen einschlägigen Bestimmungen der Richtlinie 1999/5/EG befindet. Weitere Informationen erhältlich unter: <http://www.dnpphoto.eu/de/>

Por medio de la presente PIPO Technology Co., Ltd. declara que el Wireless Print Server cumple con los requisitos esenciales y cualesquiera otras disposiciones aplicables o exigibles de la Directiva 1999/5/CE. Para mayor información, por favor consulte el siguiente URL: <http://www.dnpphoto.eu/es/>

Con la presente PIPO Technology Co., Ltd. dichiara che questo Wireless Print Server è conforme ai requisiti essenziali ed alle altre disposizioni pertinenti stabilite dalla direttiva 1999/5/CE. Per ulteriori dettagli, si prega di consultare il seguente URL: <http://www.dnpphoto.eu/it/>

PIPO Technology Co., Ltd. tímto prohlašuje, že tento Wireless Print Server je ve shodě se základními požadavky a dalšími příslušnými ustanoveními směrnice 1999/5/ES. Podrobnosti lze získat na následující URL: <http://www.dnpphoto.eu/en/>

PIPO Technology Co., Ltd. vakuuttaa täten että Wireless Print Server tyypin laite on direktiivin 1999/5/EY oleellisten vaatimusten ja sitä koskevien direktiivin muiden ehtojen mukainen. Halutessasi lisätietoja, käy osoitteessa: <http://www.dnpphoto.eu/en/>

Με την παρούσα η PIPO Technology Co., Ltd. δηλώνει ότι Wireless Print Server συμμορφώνεται προς της ουσιαστικές απαιτήσεις και τις λοιπές σχετικές διατάξεις της οδηγίας 1999/5/EK. Για λεπτομέρειες παρακαλούμε όπως ελέγξετε την ακόλουθη σελίδα του διαδικτύου: <http://www.dnpphoto.eu/en/>

Niniejszym PIPO Technology Co., Ltd. oświadcza, że Wireless Print Server jest zgodne z zasadniczymi wymaganiami oraz innymi stosownymi postanowieniami Dyrektywy 1999/5/WE. Szczegółowe informacje znaleźć można pod następującym adresem URL: <http://www.dnpphoto.eu/en/>

PIPO Technology Co., Ltd. declara que este Wireless Print Server está conforme com os requisitos essenciais e outras disposições da Directiva 1999/5/CE. Para mais informações, por favor consulte o seguinte URL: <http://www.dnpphoto.eu/en/>

DNP Imagingcomm America Corporation * 4524 Enterprise Dr NW * Concord, NC 28027 * USA

© 2000-2023 DNP Imagingcomm America Corporation All rights reserved.

Appendix A: Supported Countries

In this Chapter

Supported Countries 140

Supported Countries

The following table contains the ID templates (listed by country) that are already loaded on your IDW520 system. Information regarding the particular ID requirements for each country is also referenced.

Country	Units	Width	Height
Albania	mm	40	50
Argentina Passport & Visa	mm	40	40
Australia Passport & Visa	mm	40	50
Brazil Passport & Visa	in	2	2
Canada Passport	mm	50	70
Canada Visa	mm	35	45
Canada Citizenship	mm	50	70
Canada Permanent Resident	mm	50	70
Canadian Firearms	mm	45	57

Country	Units	Width	Height
Handi Dart (Canada)	mm	32	32
Sante Quebec (Canada)	mm	50	70
Chile Passport	mm	45	45
Chile Visa	mm	45	45
China	mm	33	48
Columbia Passport	mm	38	64
Columbia Visa	mm	30	40
Dominican Republic Passport	mm	50	50
Dominican Republic Visa	in	2	2
Ecuador Passport & Visa	mm	50	50
European Union Passport & Visa	mm	35	45

Country	Units	Width	Height
Finland	mm	36	47
France	mm	35	45
Germany Passport & Visa	mm	35	45
Greece Passport	mm	40	60
Greece Visa	mm	35	45
Hong Kong	mm	40	50
India Passport	in	2	2
Israel	mm	50	50
Italy	mm	35	45
Jamaica	mm	35	45
Japan Passport	mm	35	45
Japan Visa	mm	45	45

Country	Units	Width	Height
Japan Residence	mm	30	40
Mexico Passport & Visa	mm	35	45
Pakistan	mm	35	45
Peru Passport & Visa	in	2	2
Russia	mm	35	45
Spain	mm	30	40
UAE Passport & Visa	mm	43	55
UK	mm	35	45
US	in	2	2
Uruguay Passport & Visa	in	2	2
Vietnam Passport	mm	40	60
Vietnam Visa	in	2	2

DNP Imagingcomm America Corporation

4524 Enterprise Dr. NW

Concord, NC 28027

1-855-367-7604

www.dnpphoto.com

www.dnpimagingcomm.com

Technical Support Contact Information

Phone US and Canada: 1-855-367-7604 or +1-980-777-1178

Phone Latin America: 1-855-367-8008 or +1-980-777-1175

Email: dnpsupport@dnp.imgcomm.com